

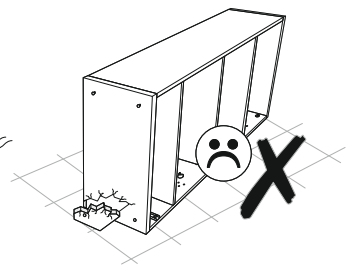

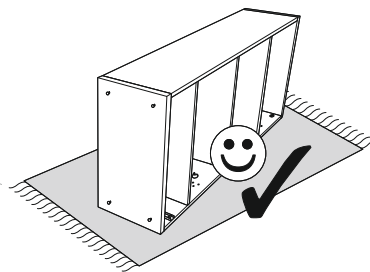

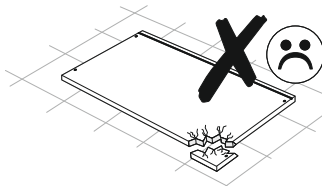

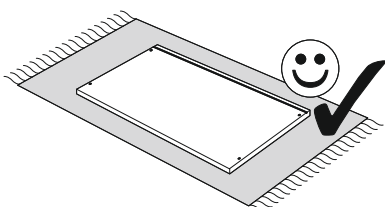

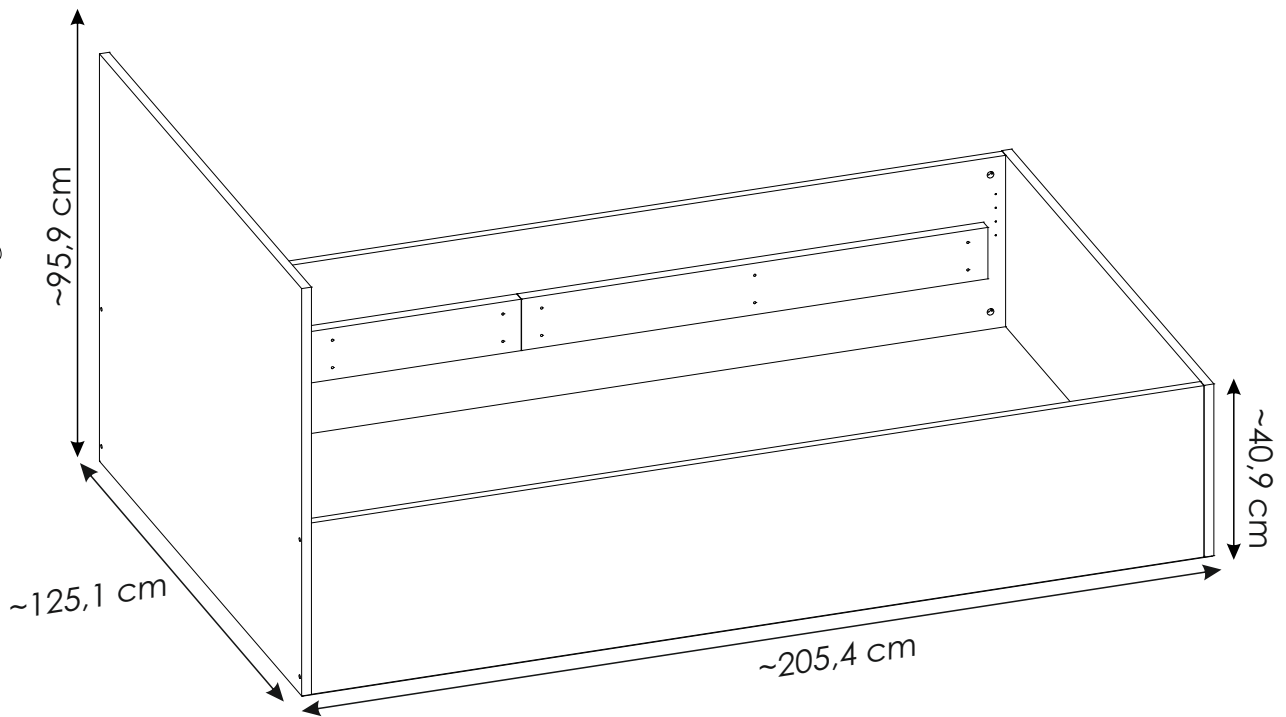
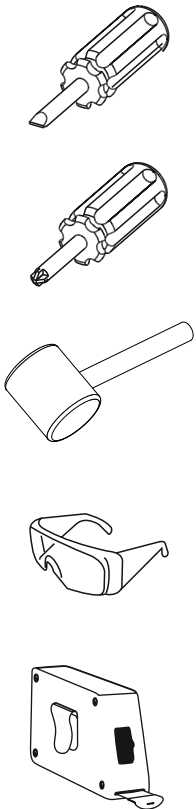
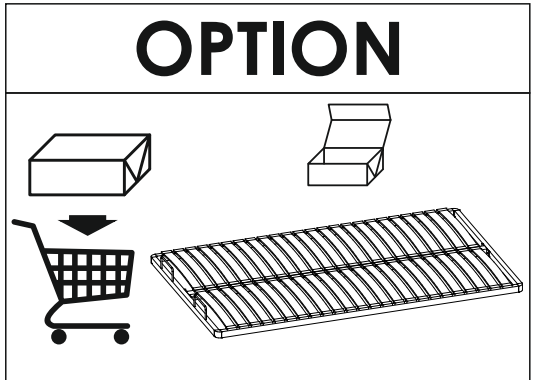
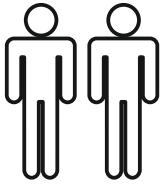
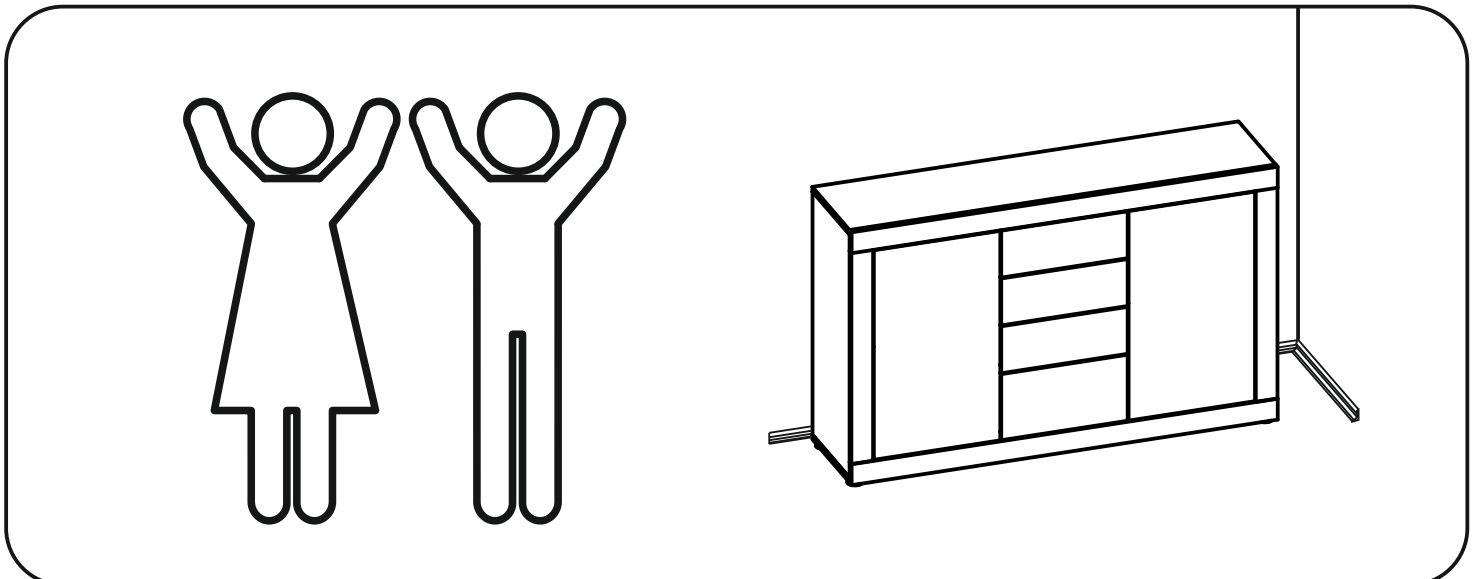
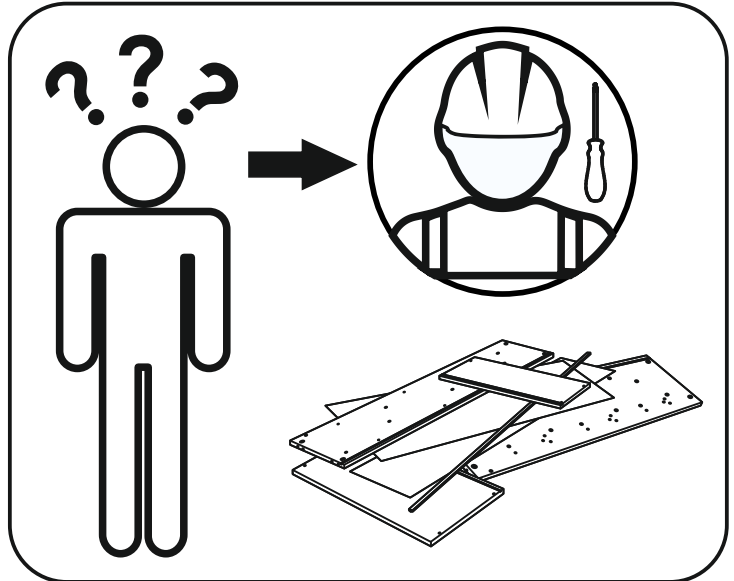
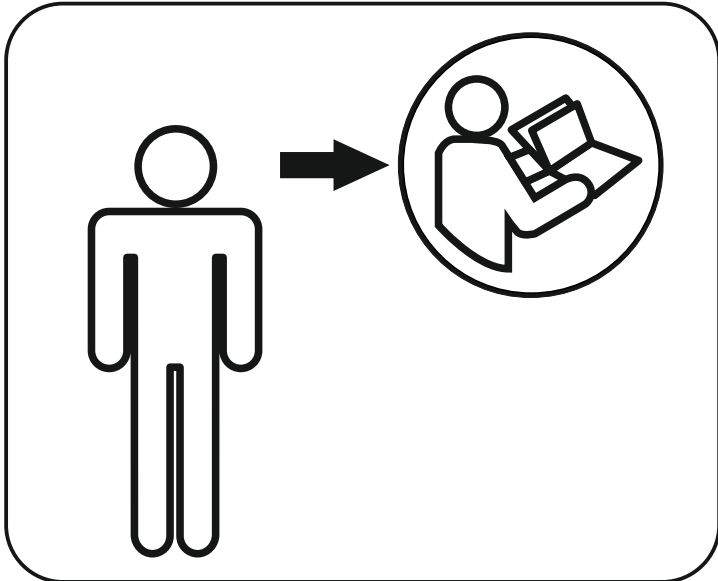
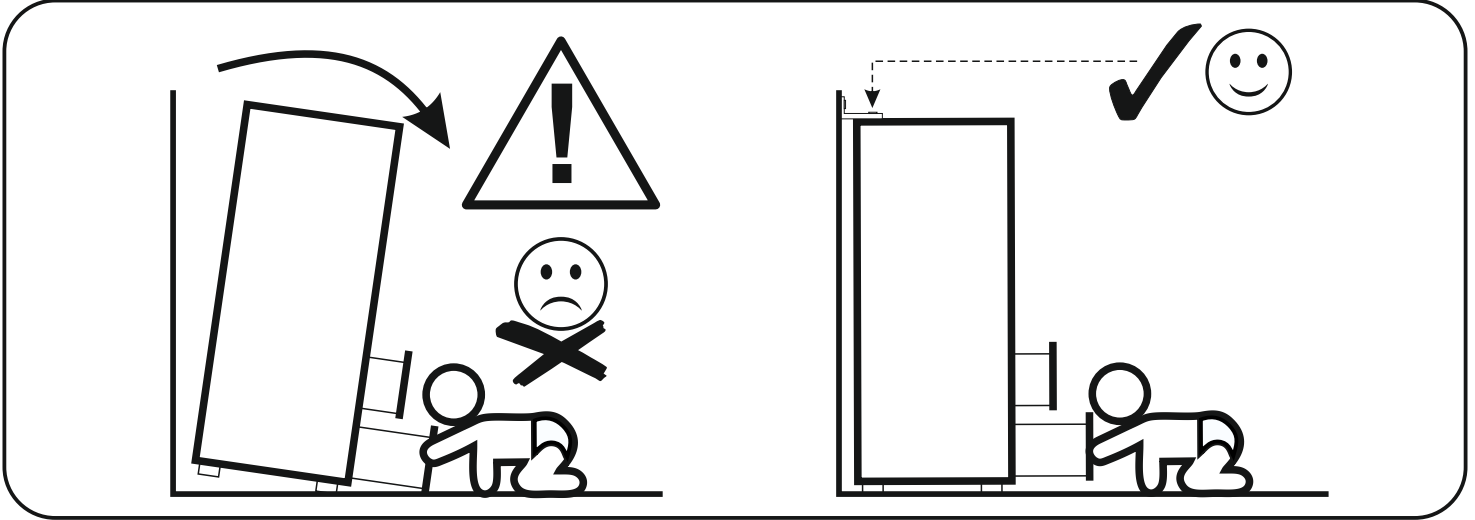



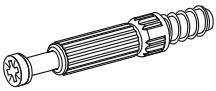
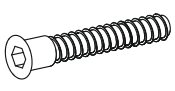

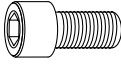
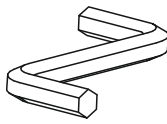
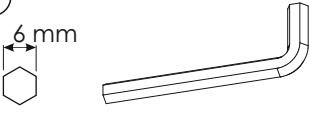
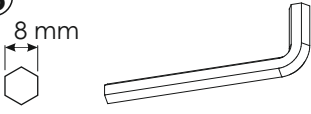
FANZ02



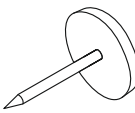

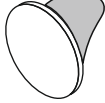
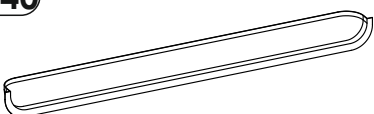
FANZ02

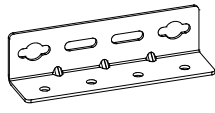
A1 8 x 35 mm x12 	A6 8 x 24 mm x12 	E1 15 x 12 mm x4 
F1 6 x 34 mm x4 	G2 7 x 60 mm x4 	I0 3 x 13 mm x10 
I9 4 x 20 mm x32 	K50 8 x 25 mm x6 	M x1 
M7 6 mm x1 	M8 8 mm x1 	N1 3 x 16 mm x55 
N17 4 x 45 mm x24 	O2A ø20 x12 	O2 x16 
P16 x24 ø14 	P17 x4 ø20 	P40 x2 
S10 x6 	S18 x6 	W14 x4 

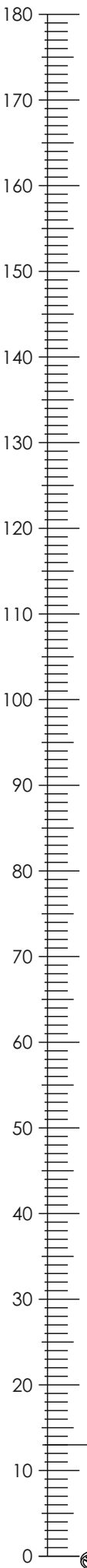

FANZ02

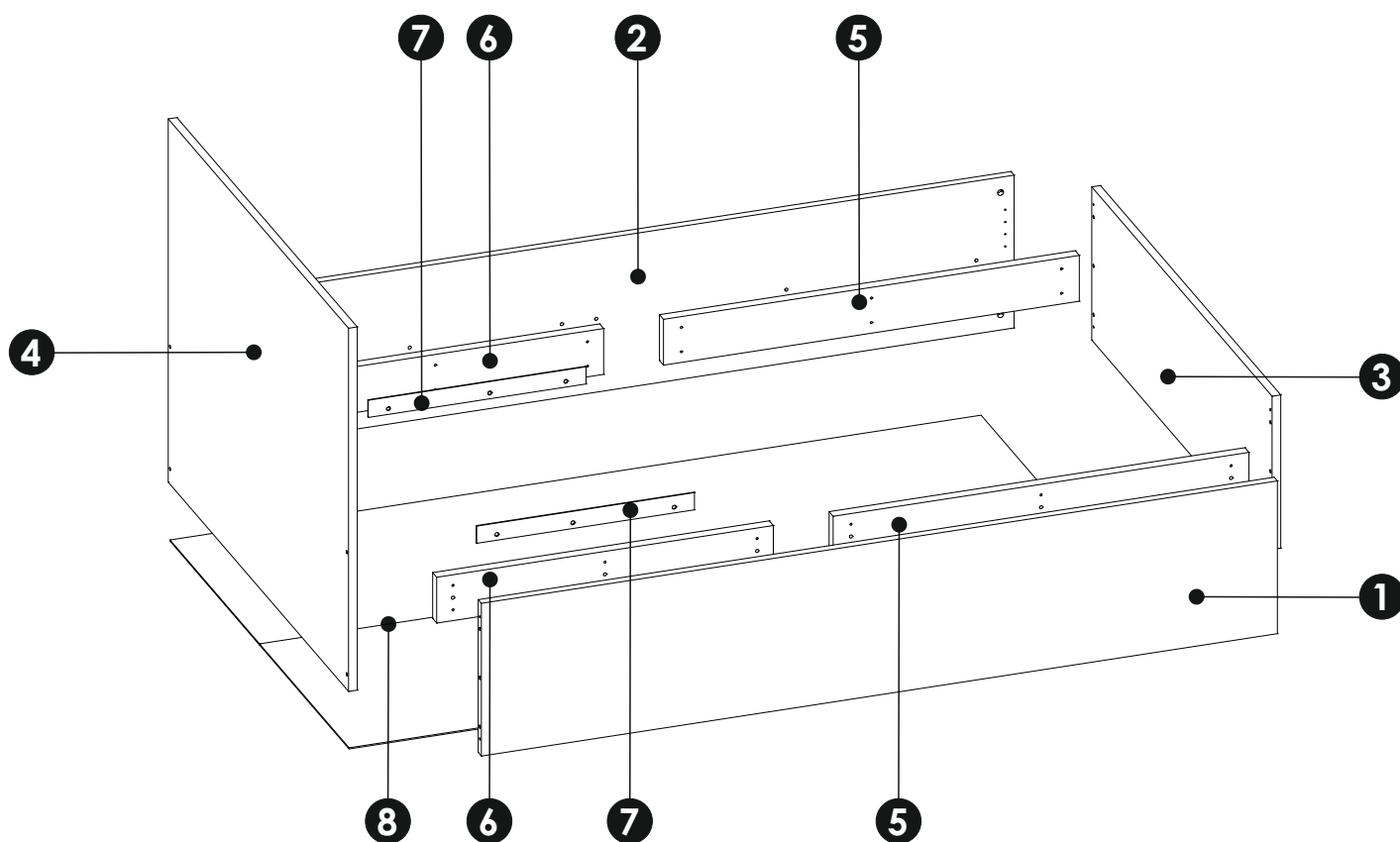
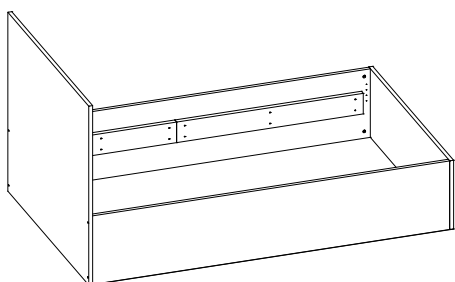

1	2010	400	22	x1	2/2
2	2010	400	22	x1	2/2
3	1251	401	22	x1	1/2
4	1251	951	22	x1	1/2
5	1050	120	28	x2	1/2
6	850	120	28	x2	2/2
7	550	45	3	x2	1/2
8	2048	1242	3	x1	2/2

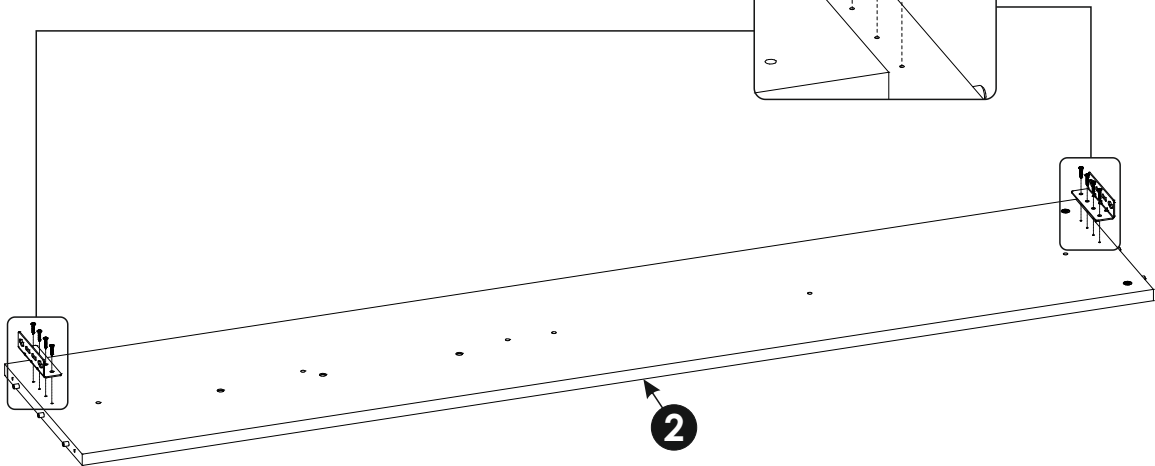
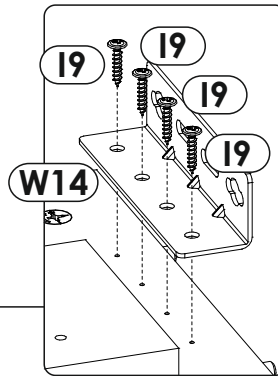
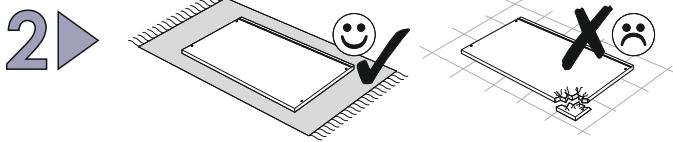
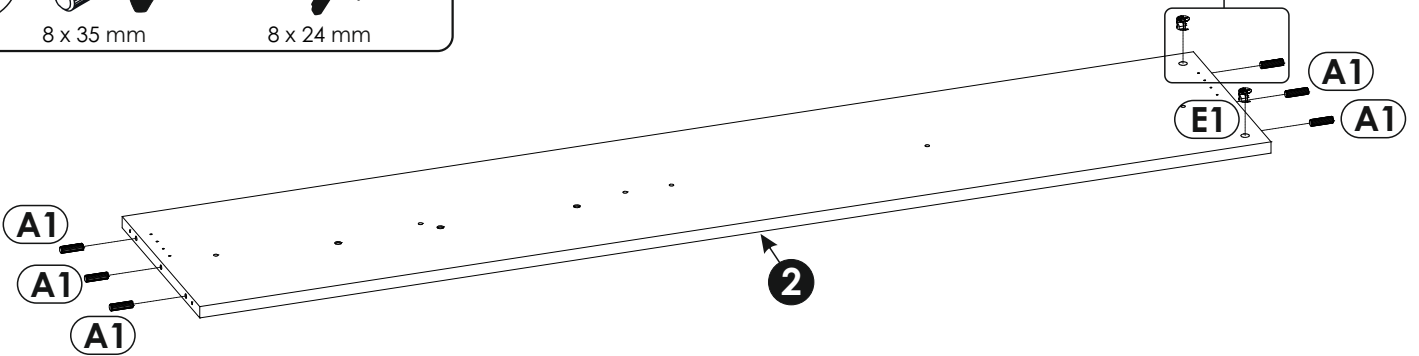
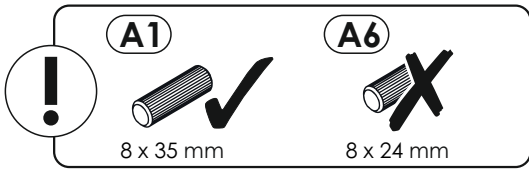
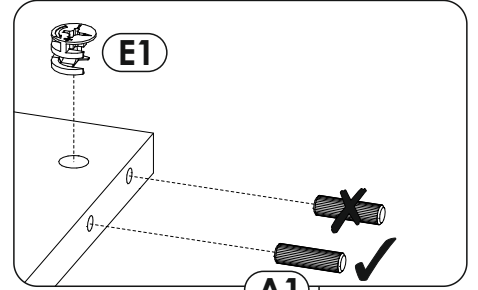
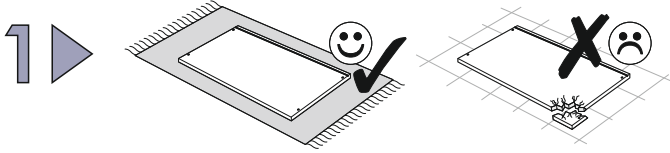
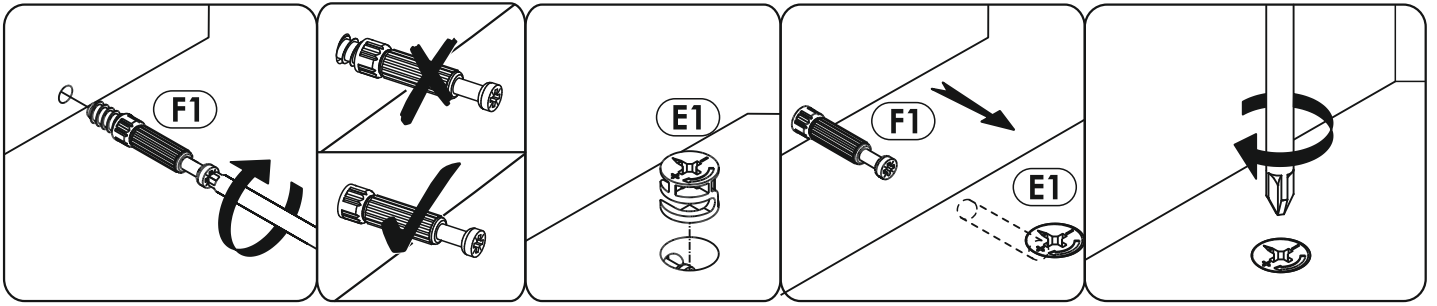

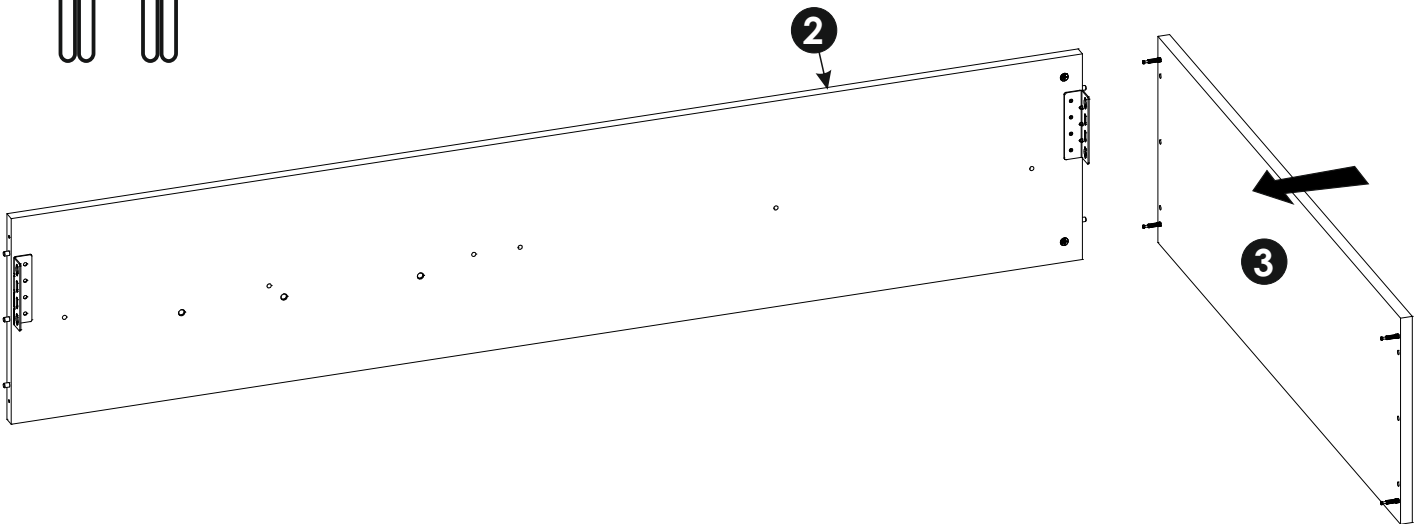
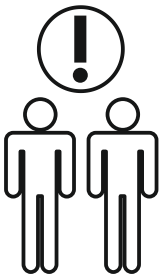
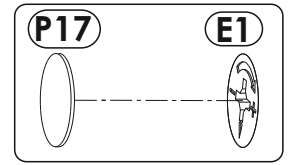
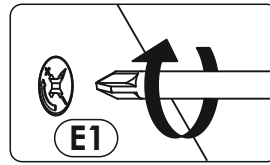
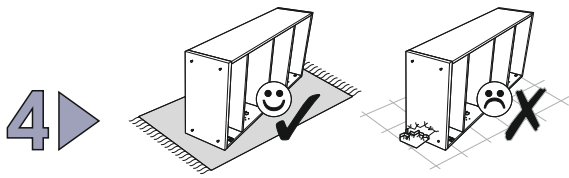
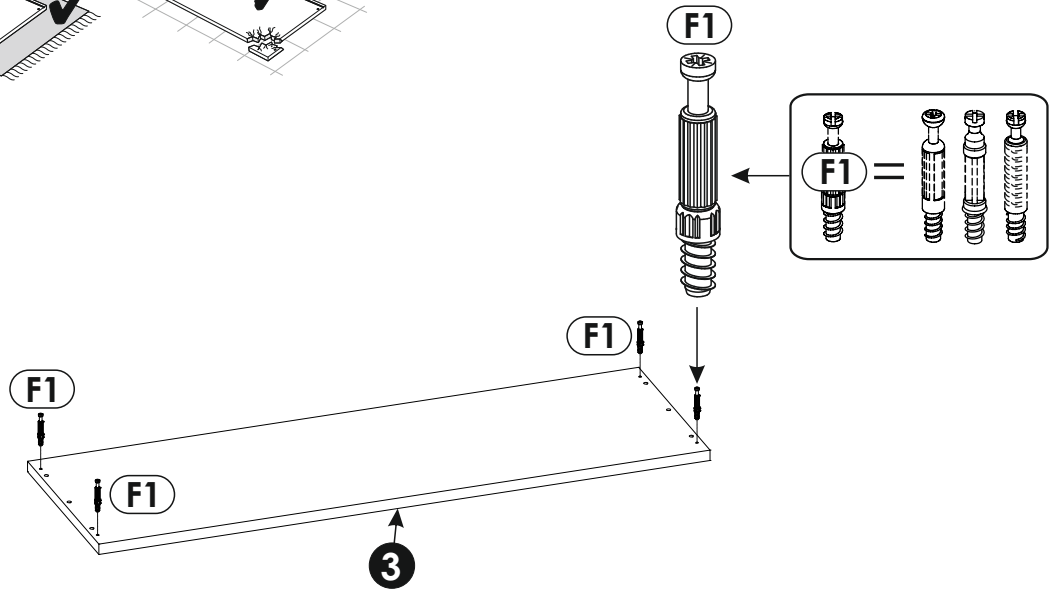
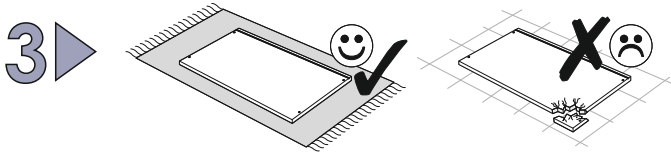

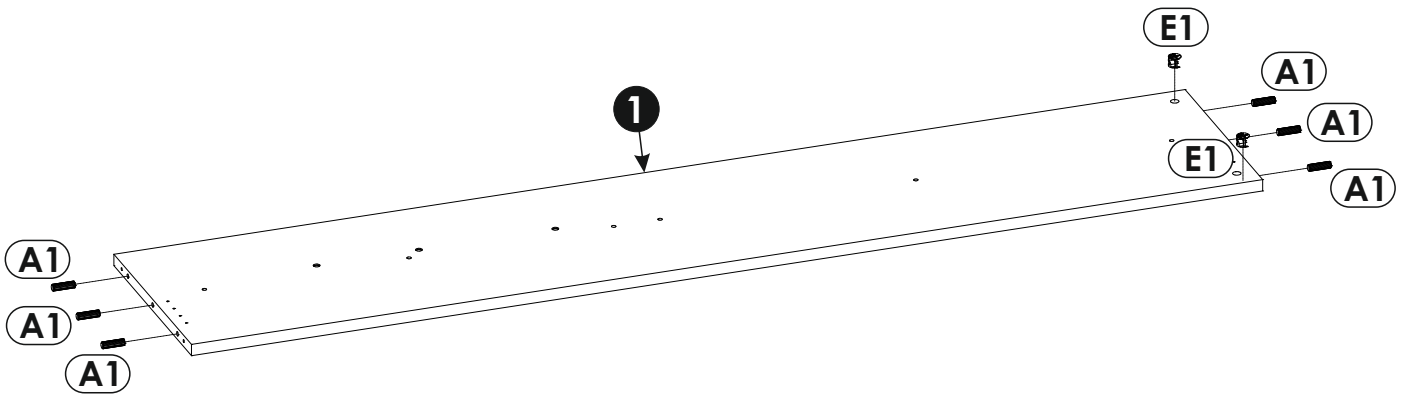
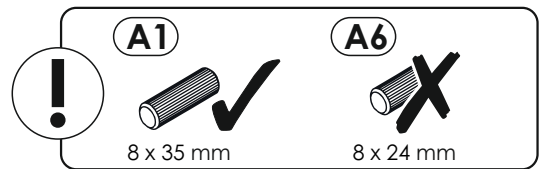
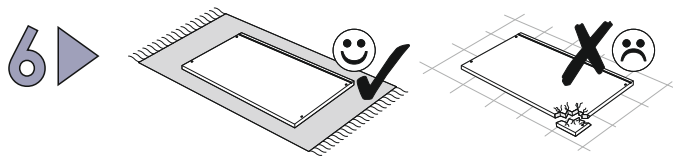
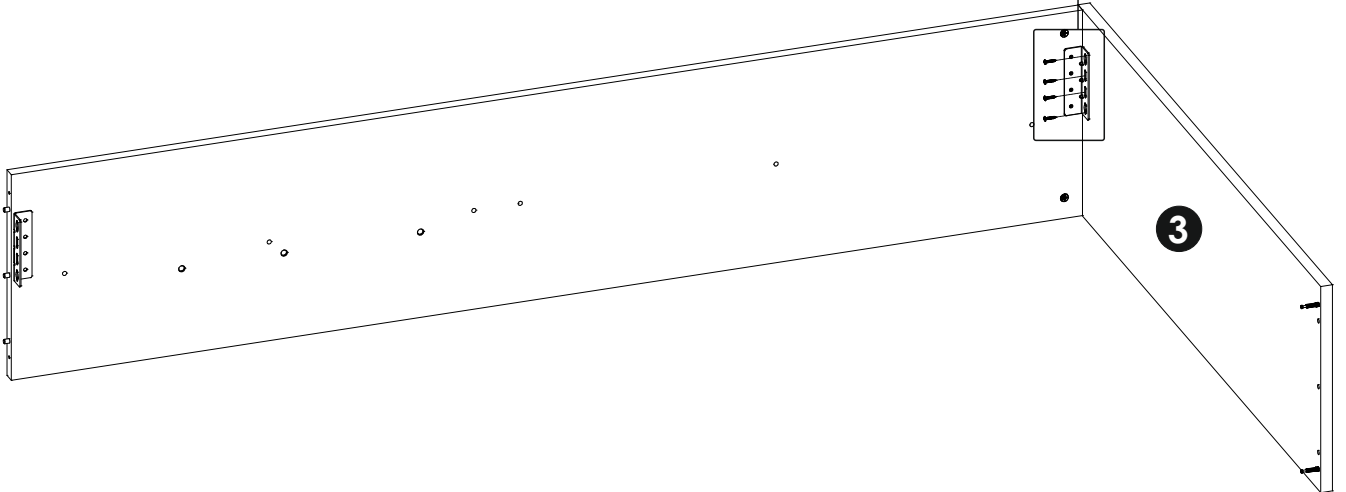
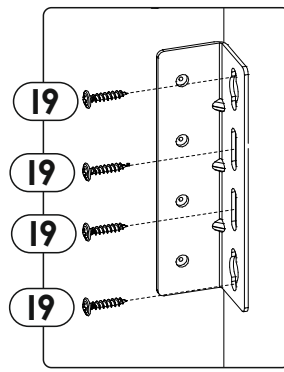
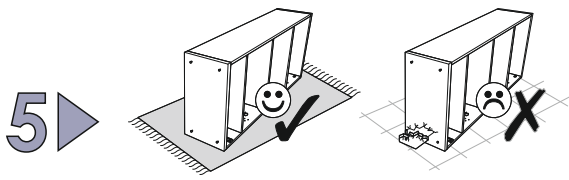

7 ▶

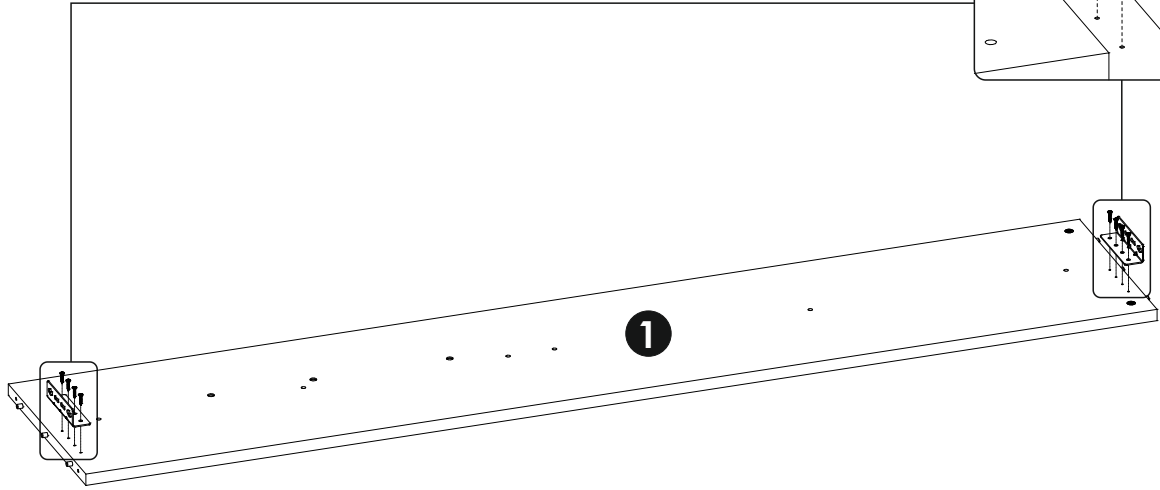
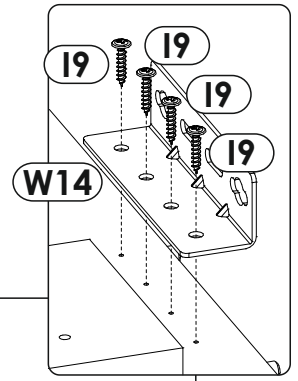
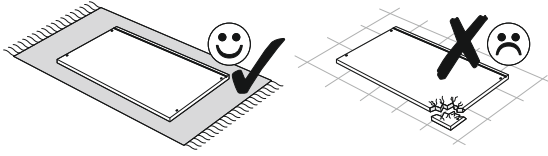

8 ▶

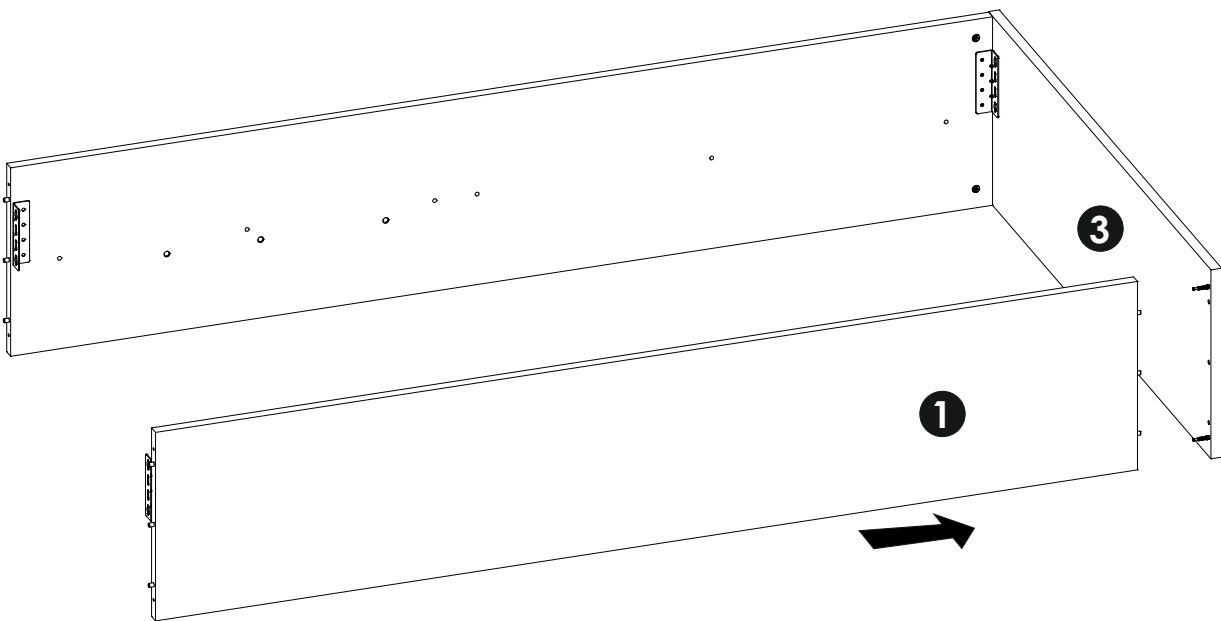
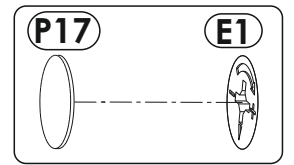
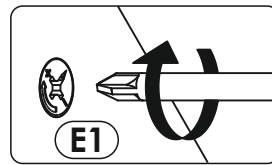
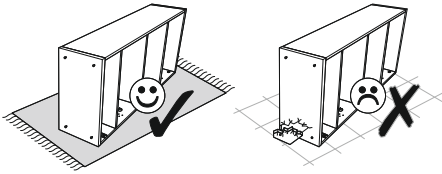

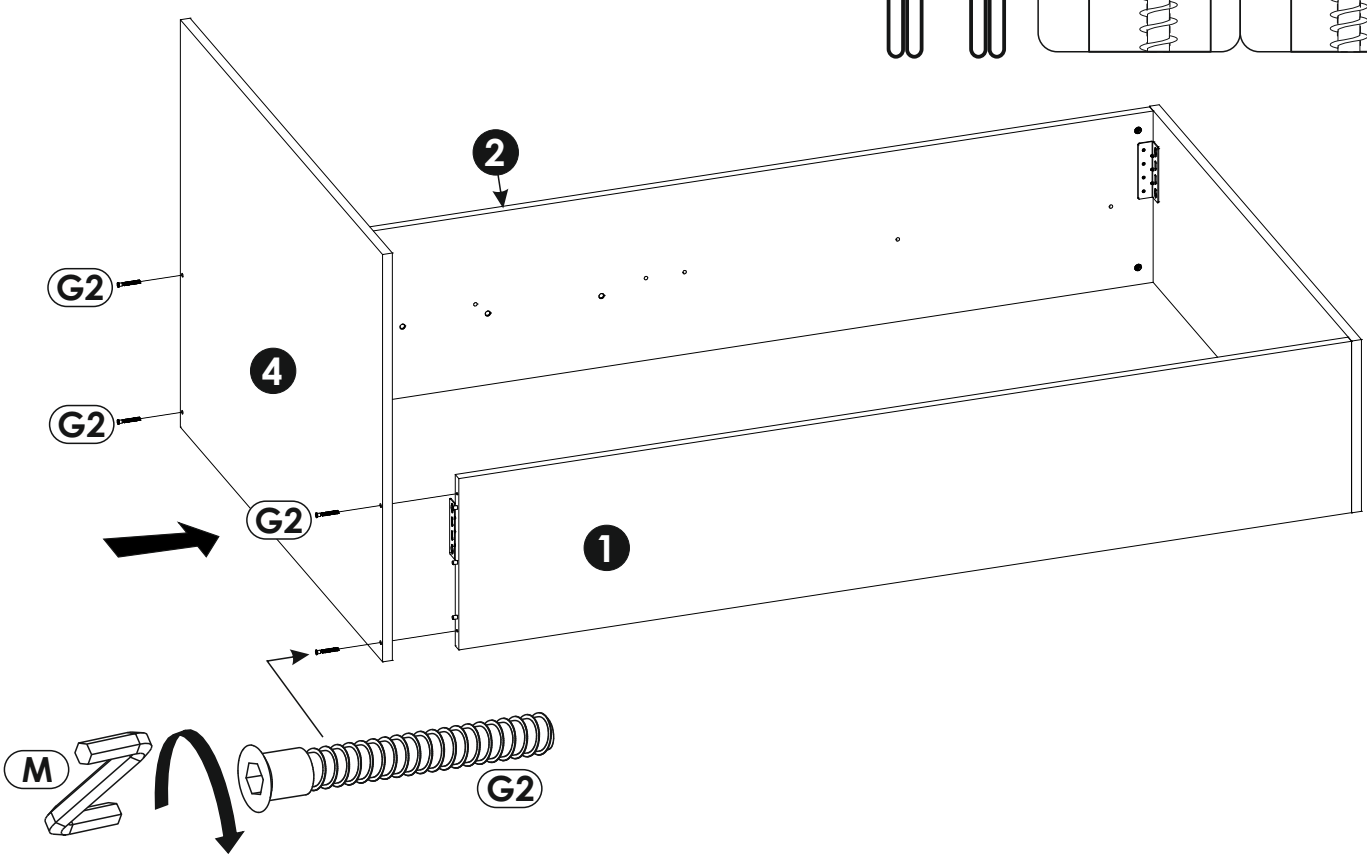
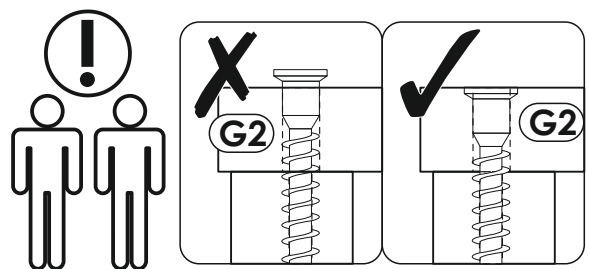
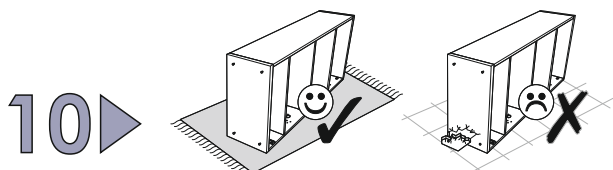
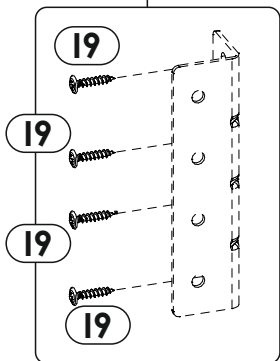
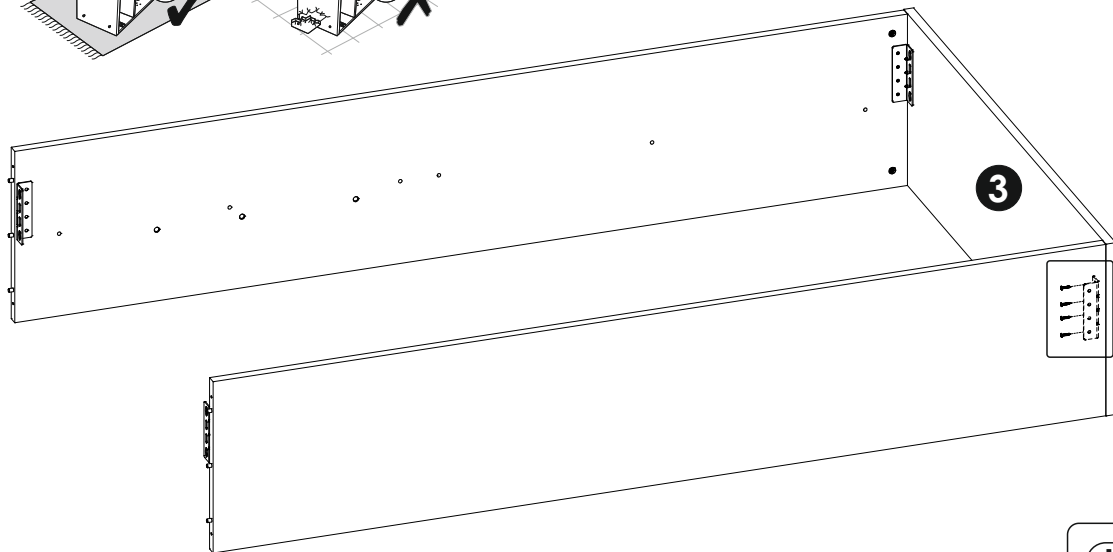
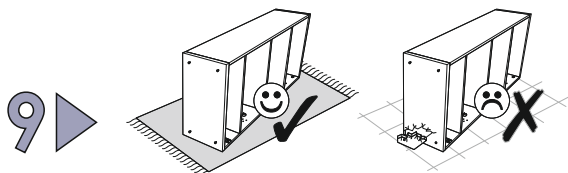

11 ▶

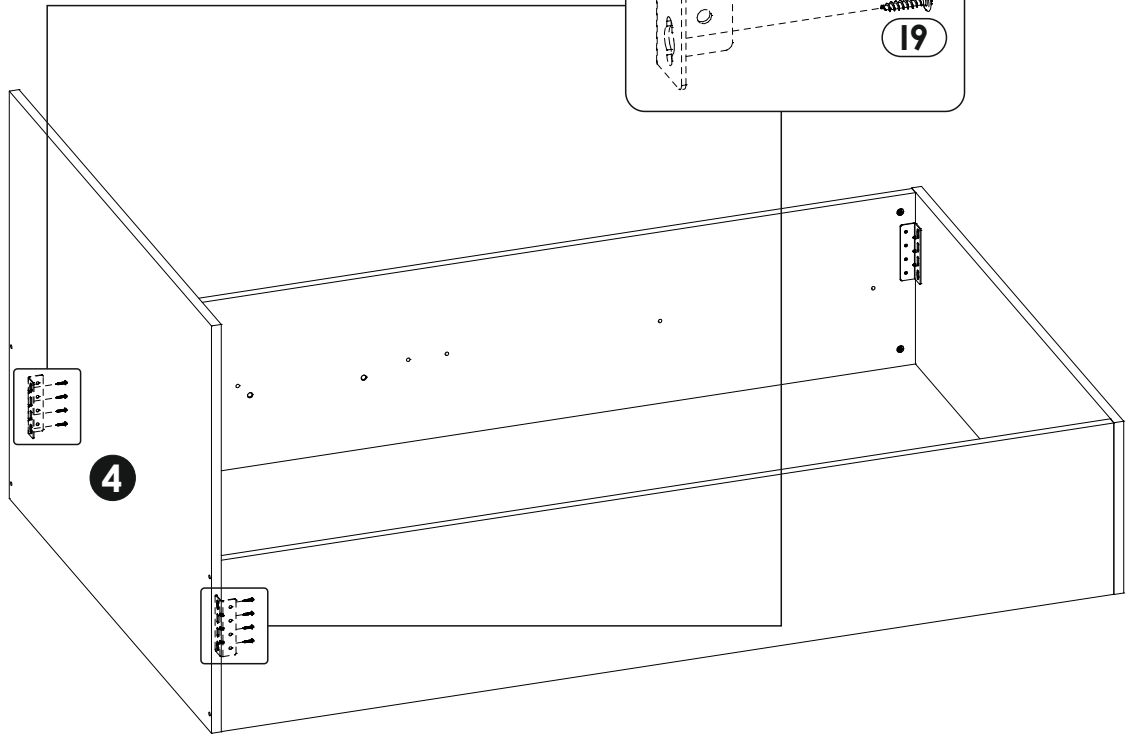
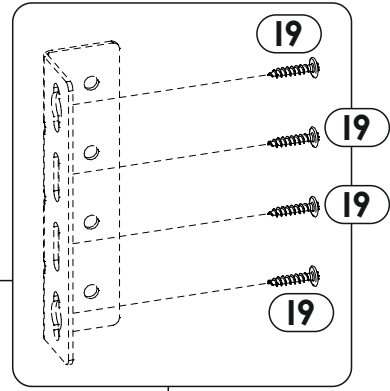
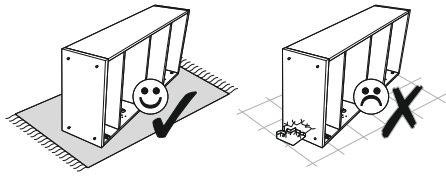

12 ▶

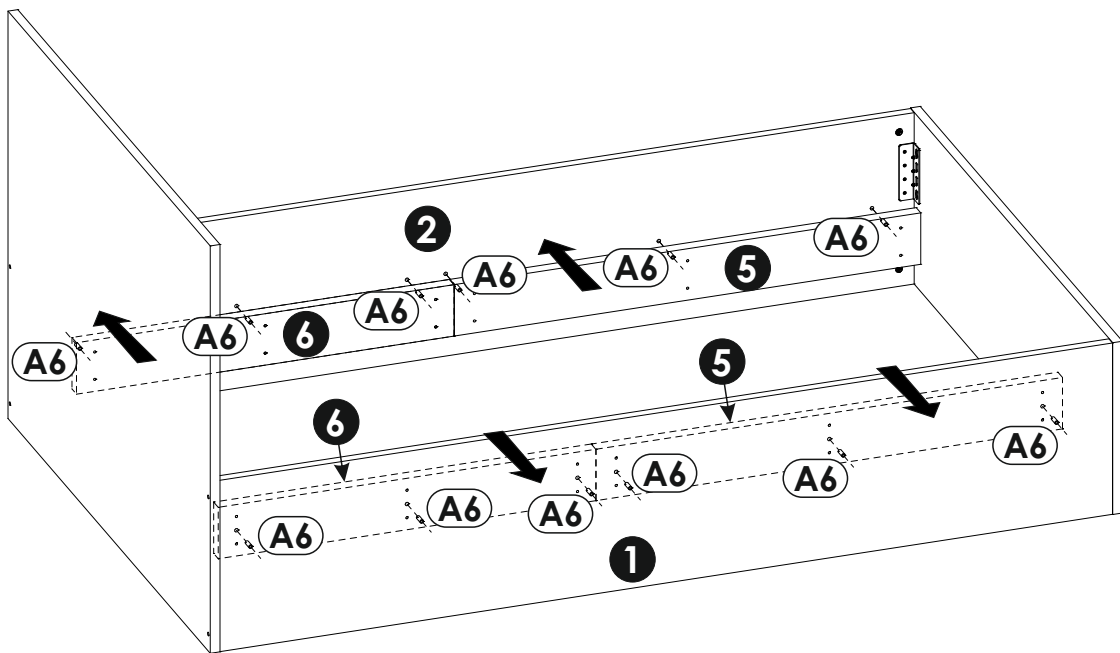
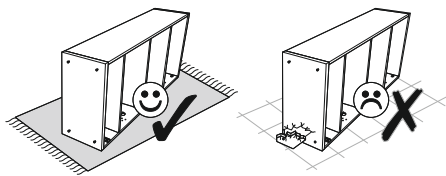

13▶

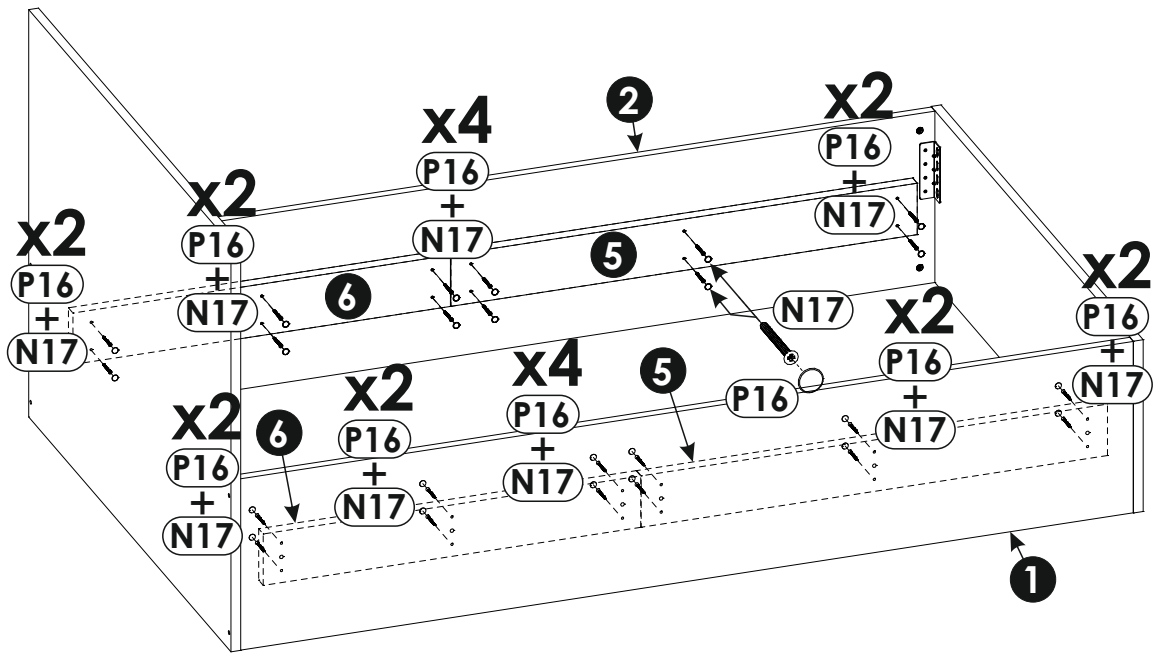
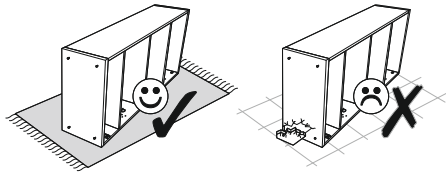

14▶

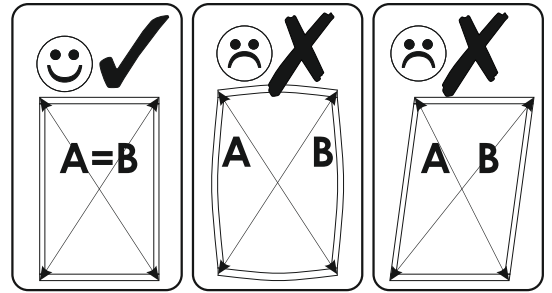
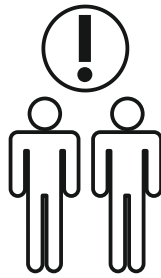
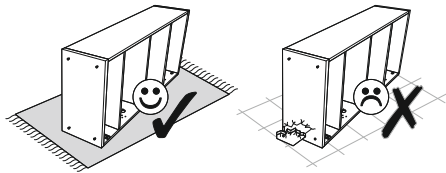

A=B

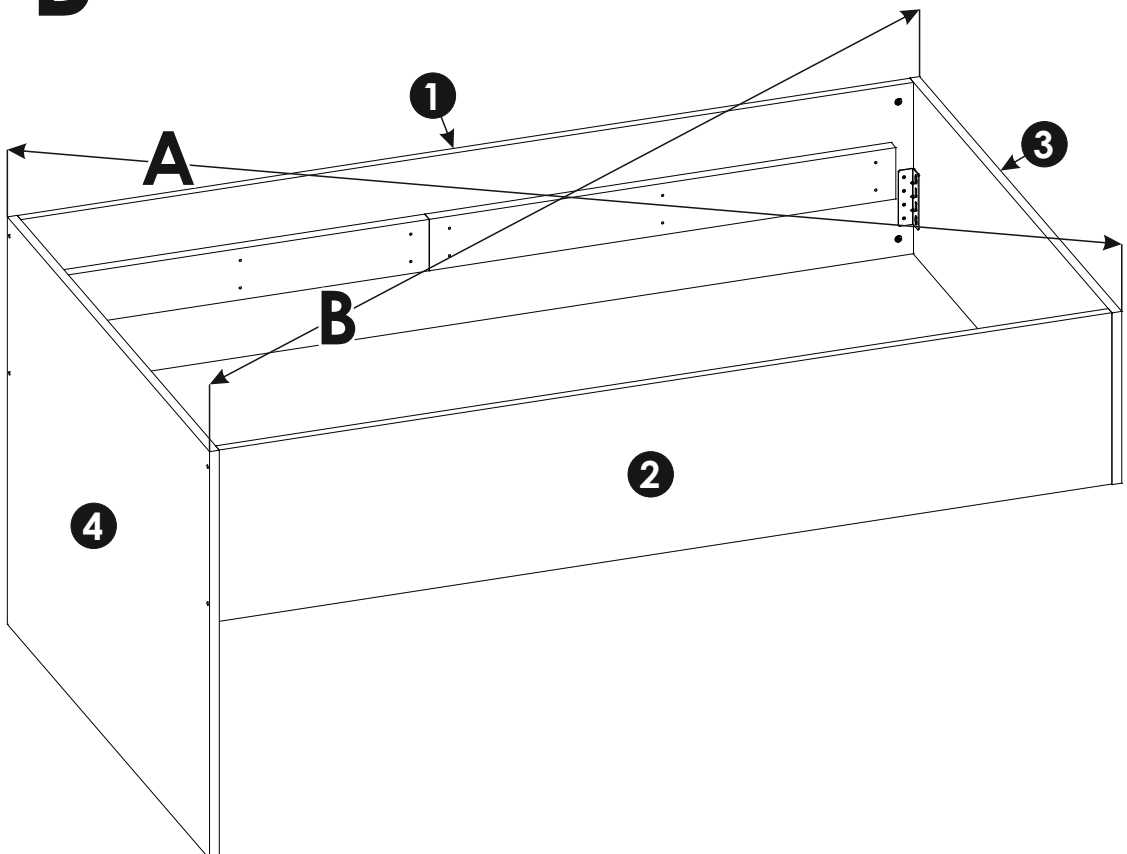

15▶

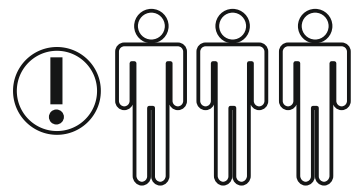
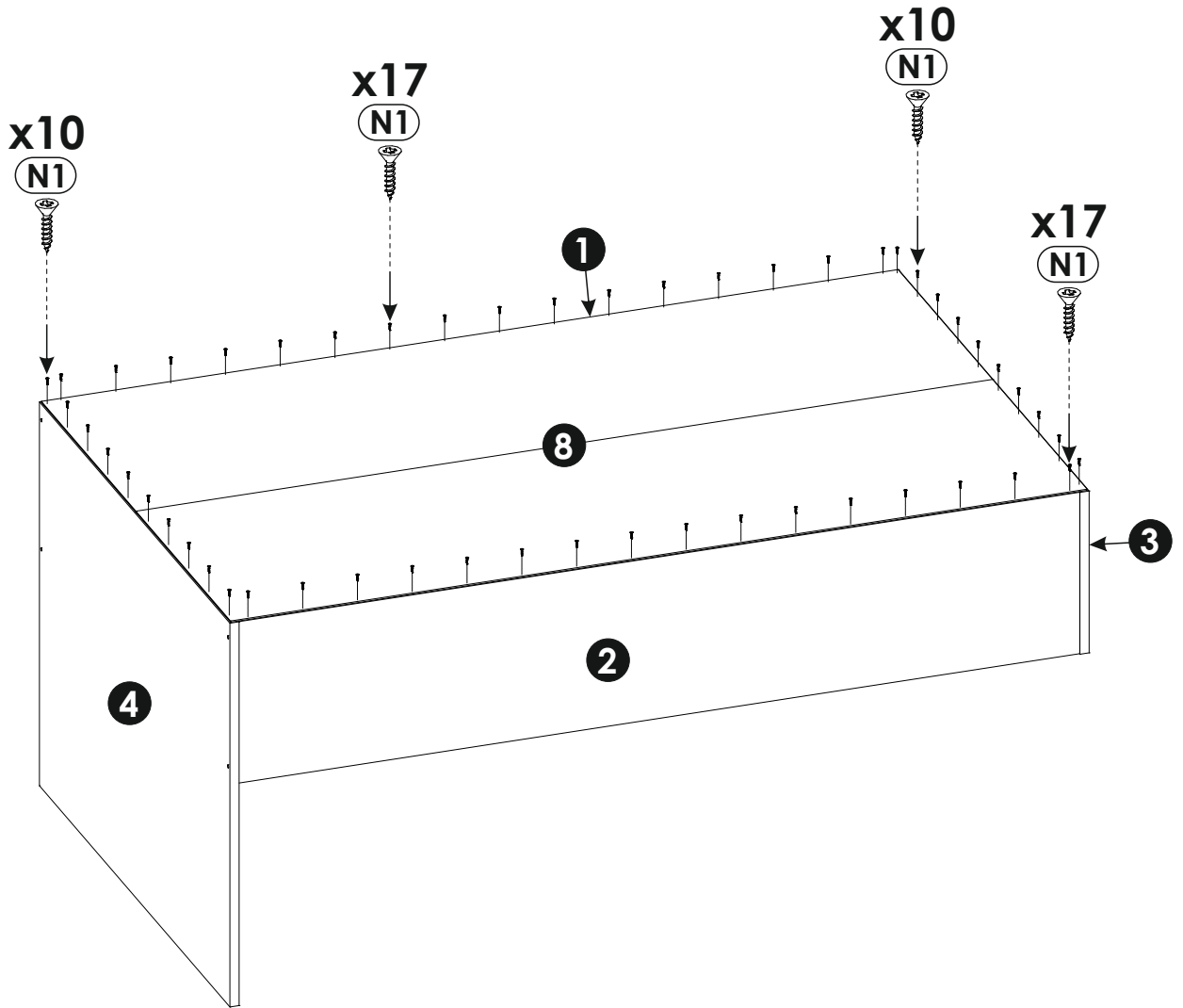
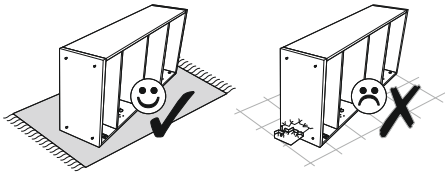

16 ▶

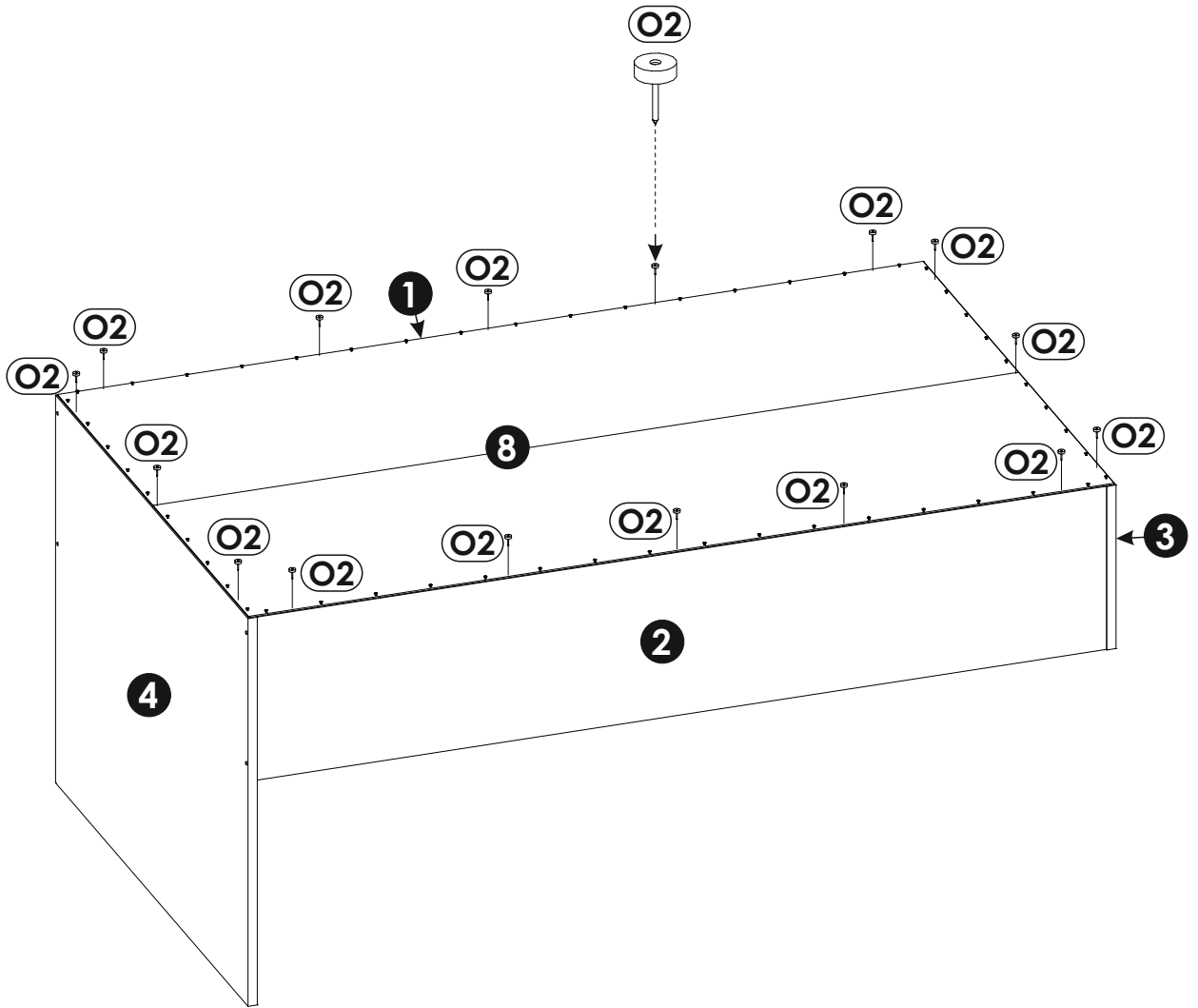
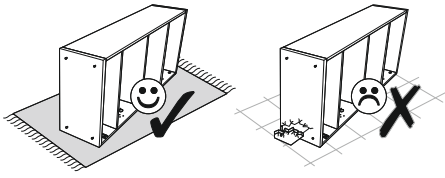

OPTION

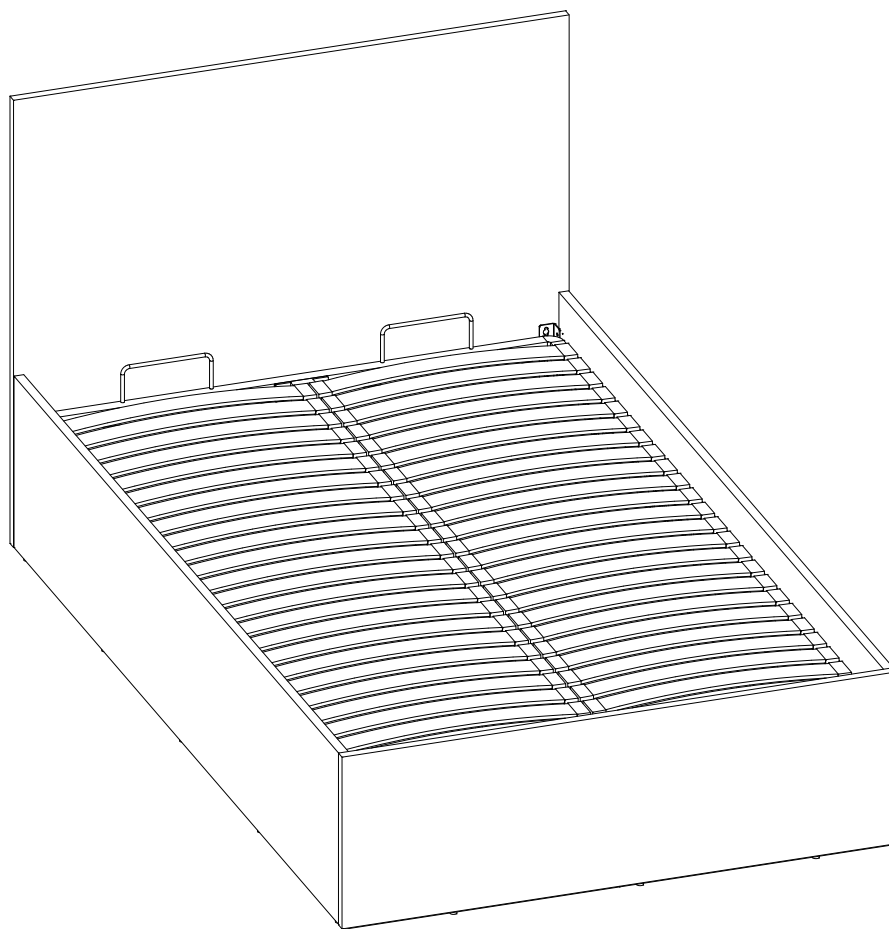

17▶

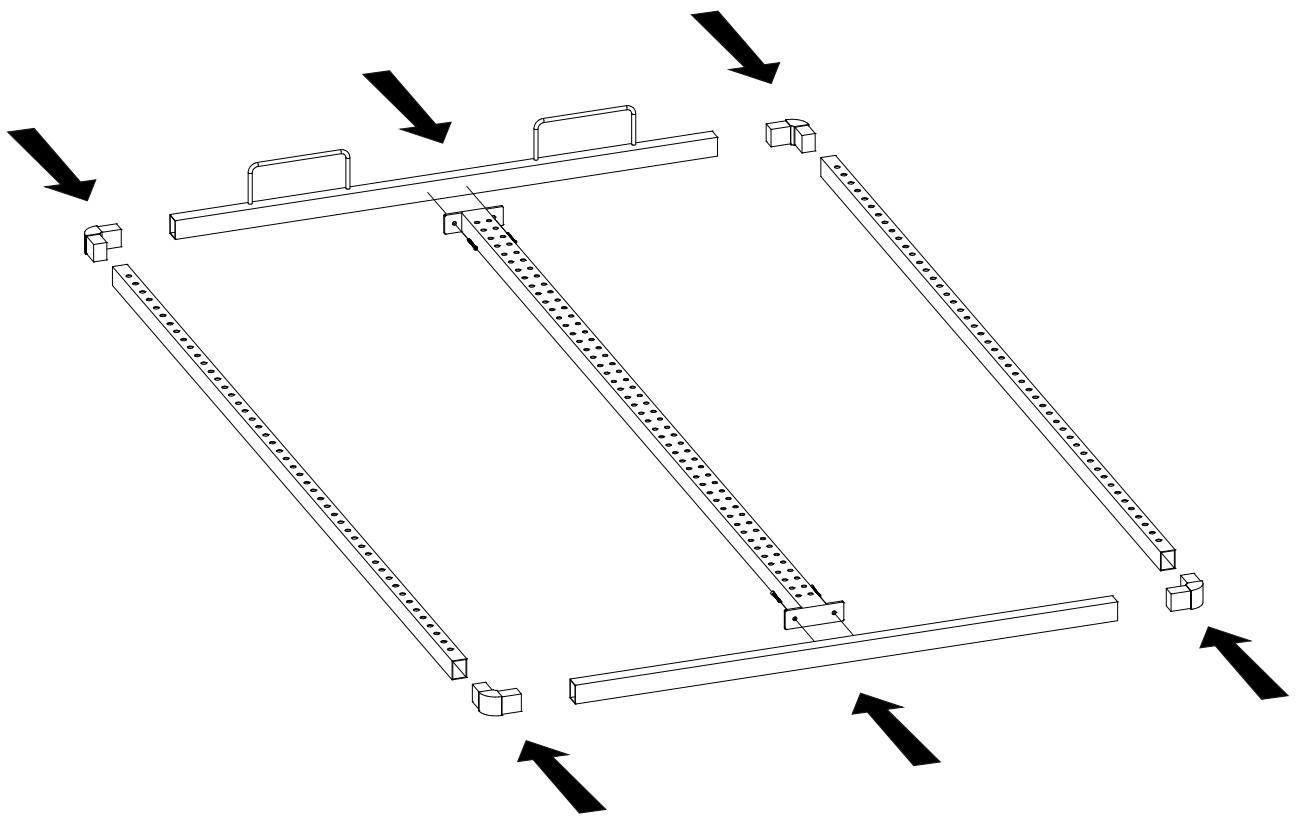

18▶

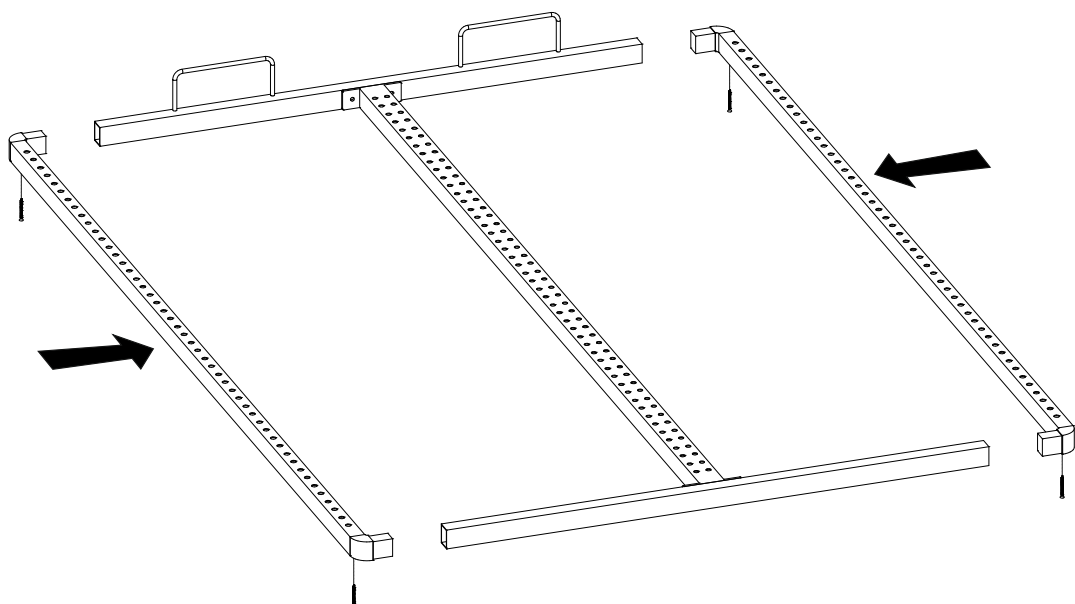

19▶

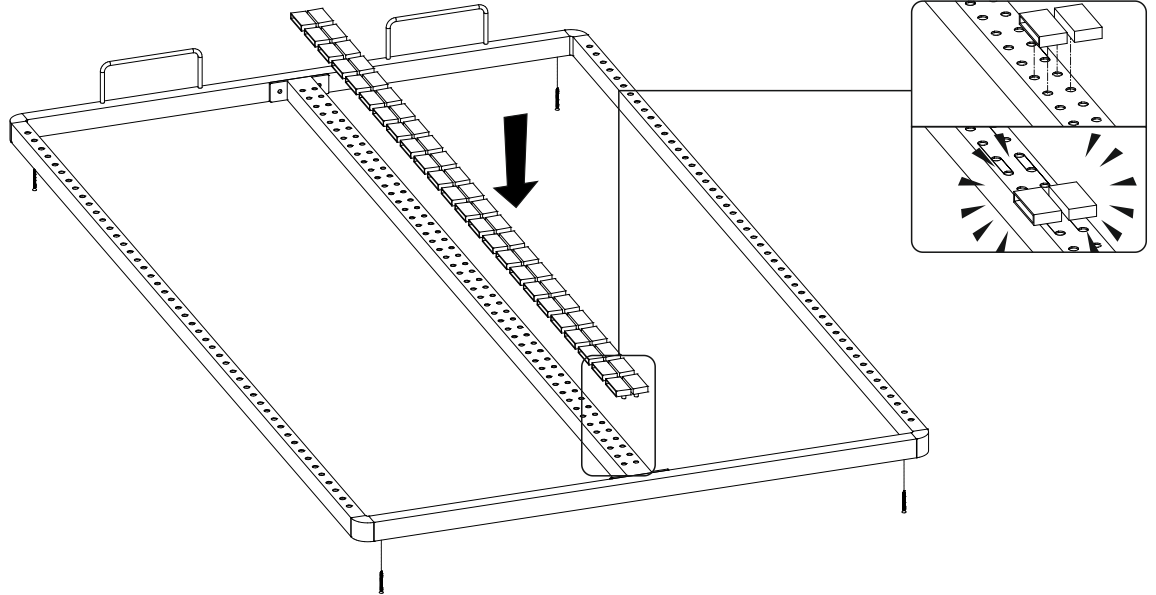

20▶

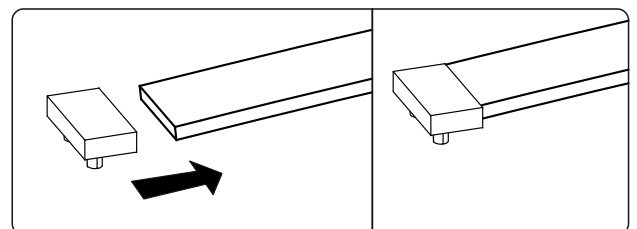
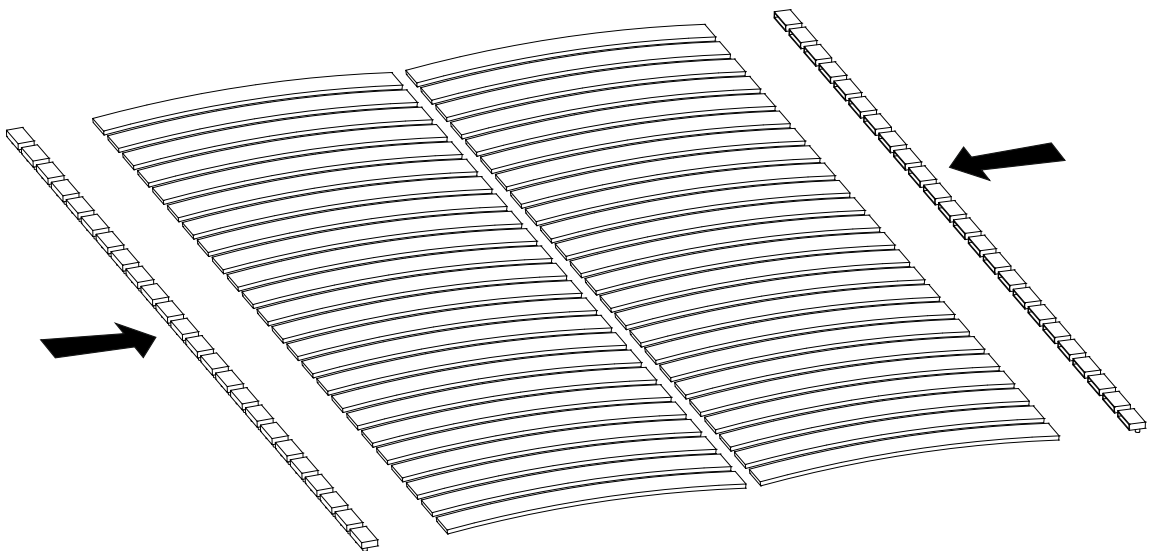

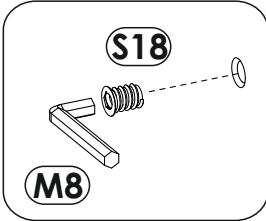
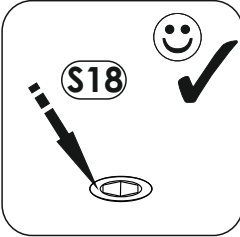
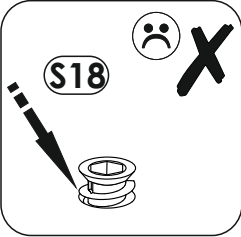
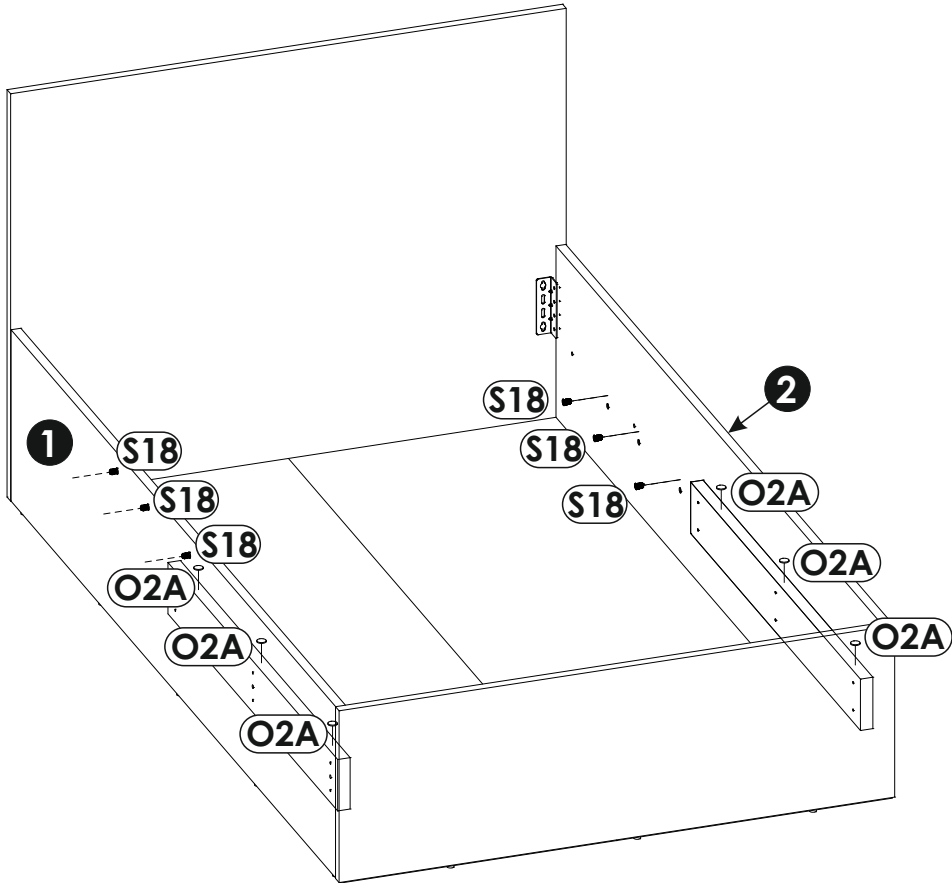

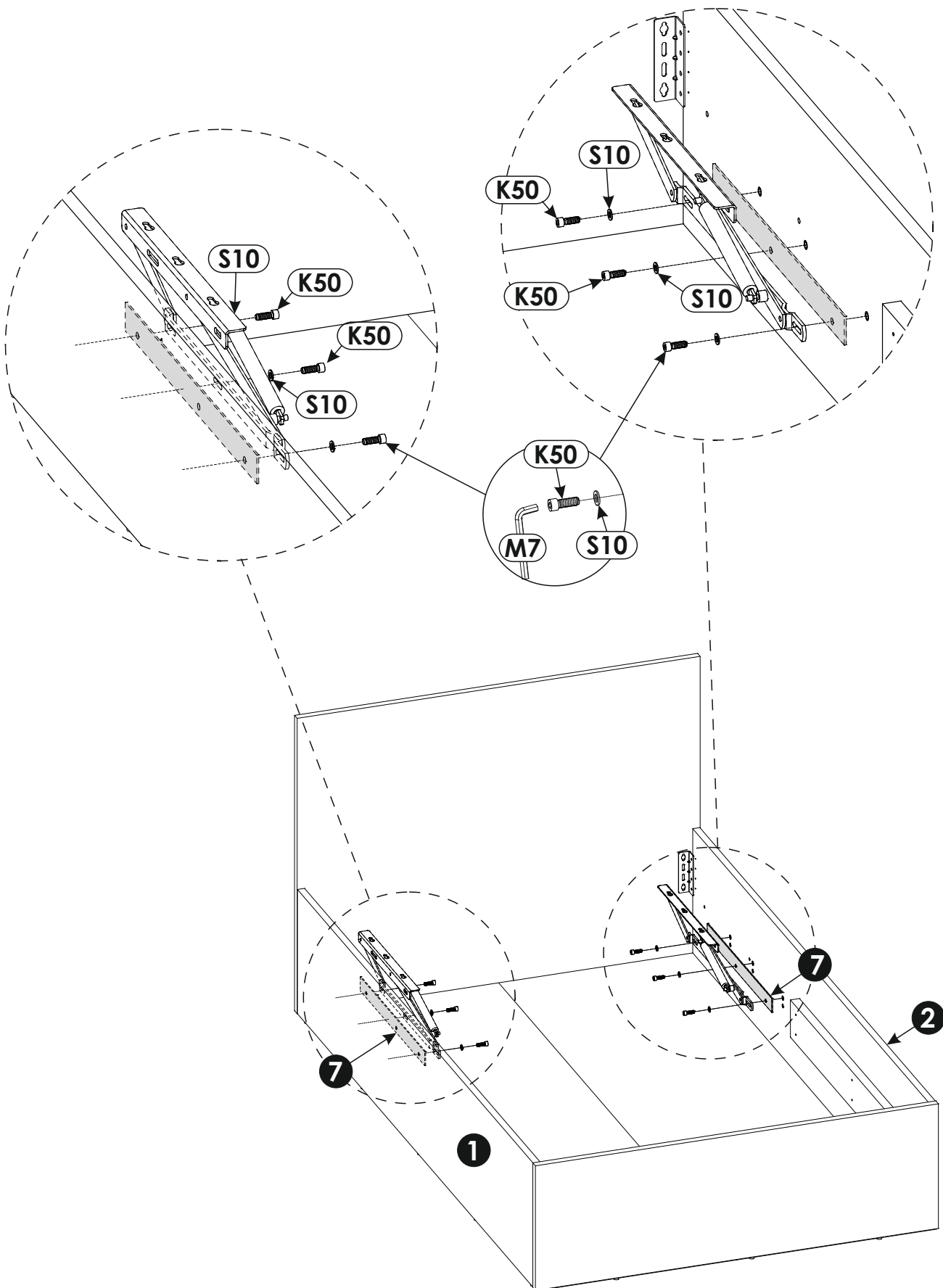

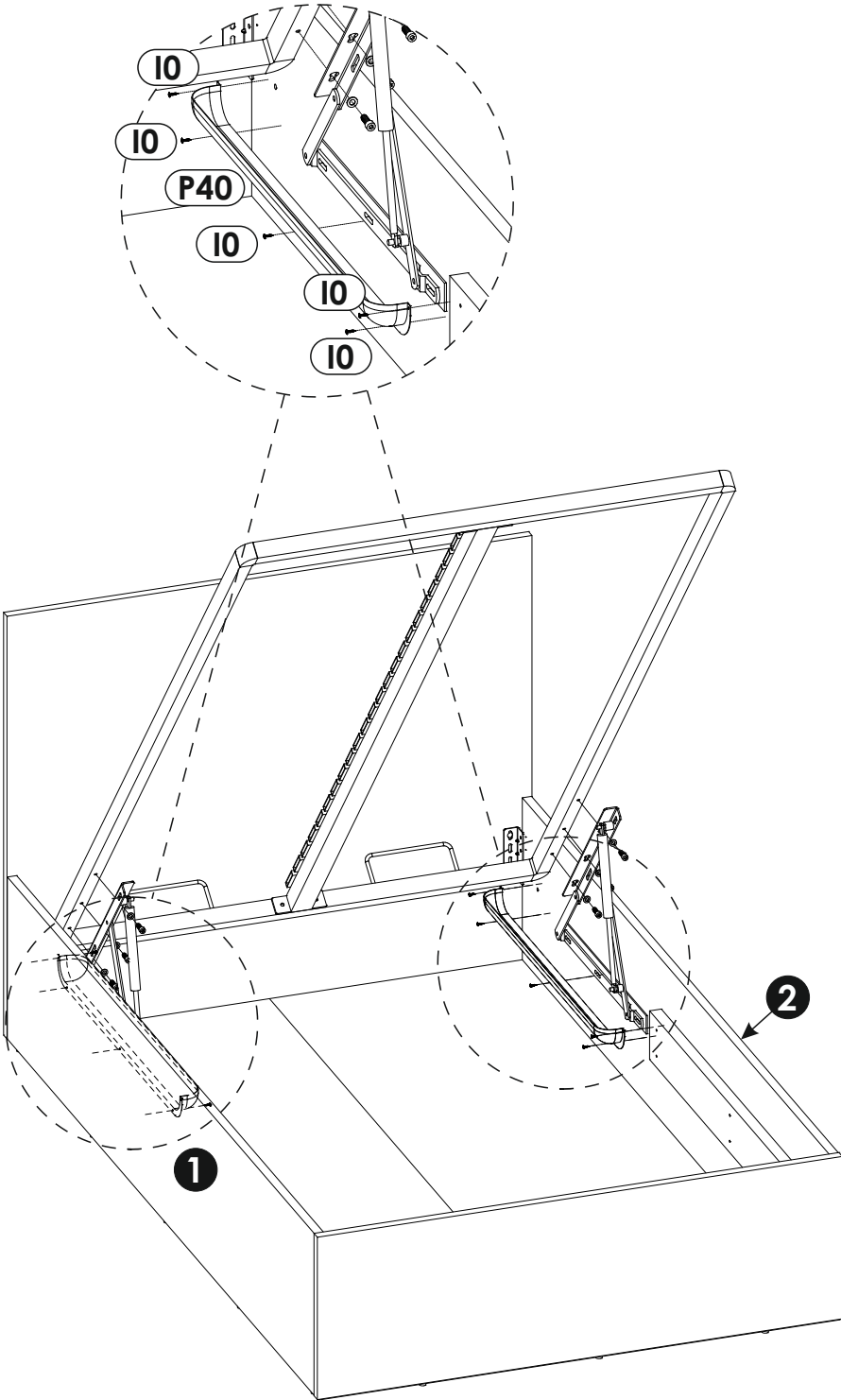

24▶

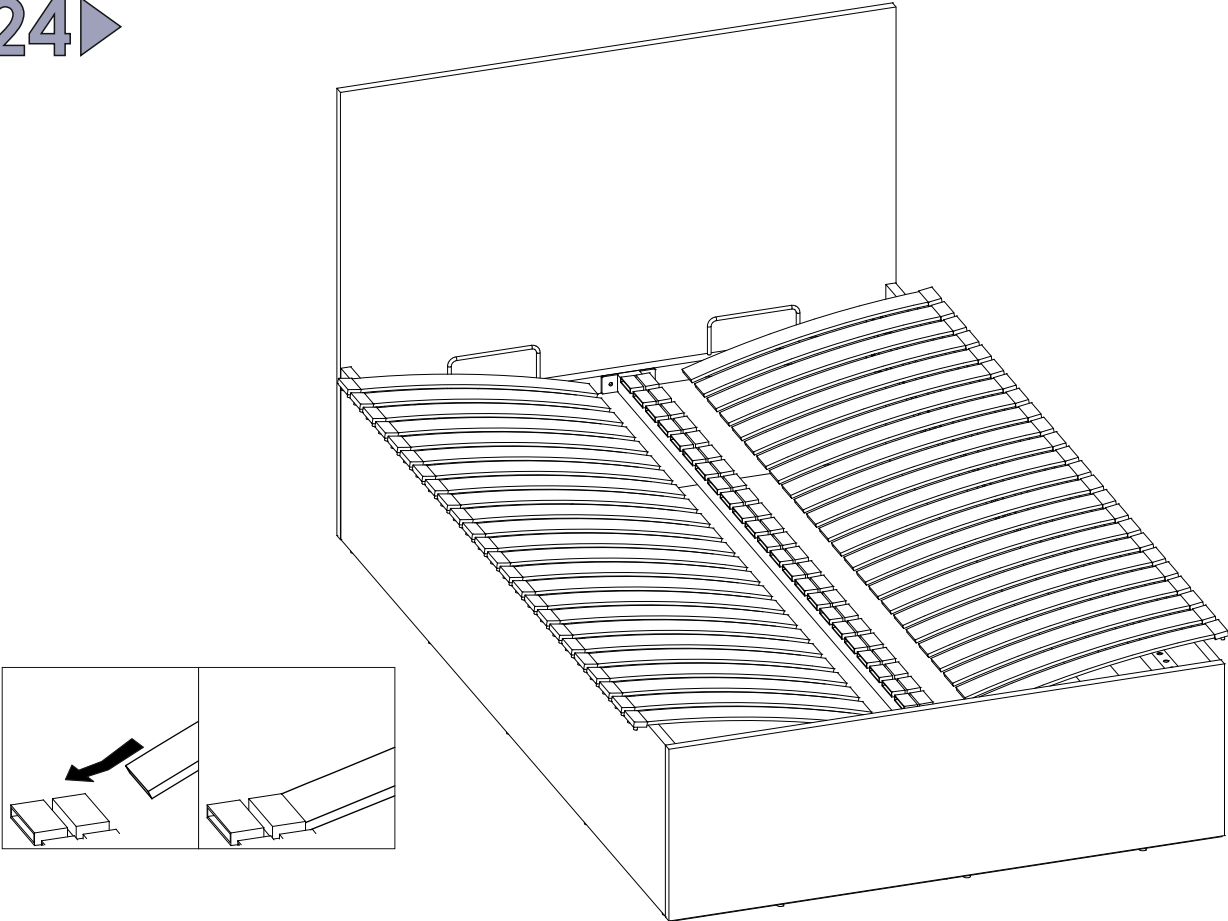

25▶

