

# FANZ03

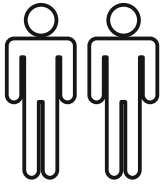

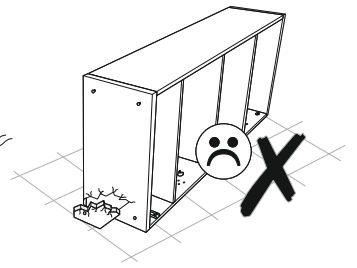

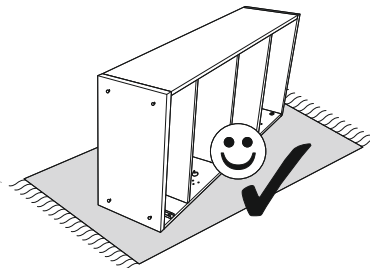

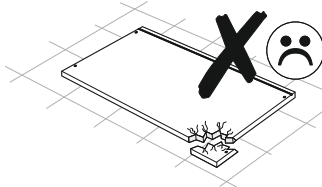
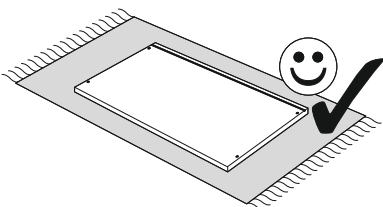
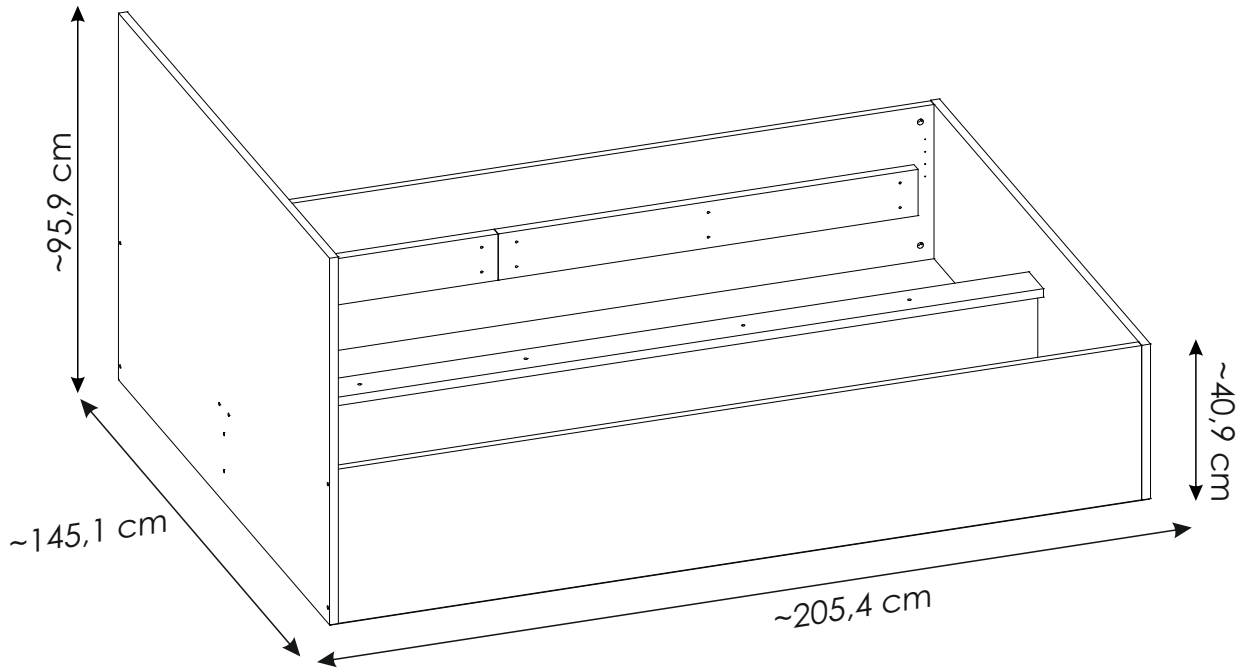
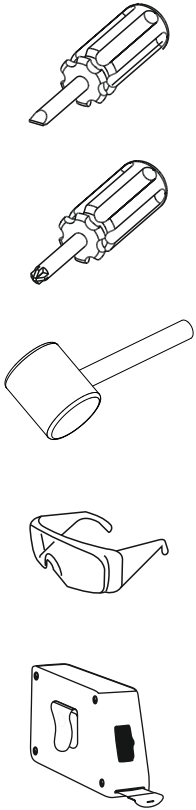
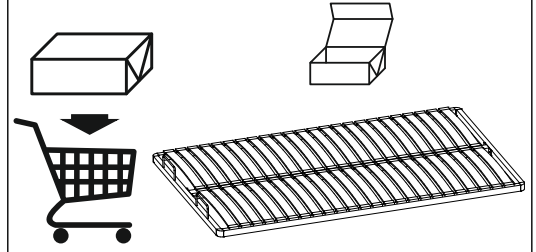
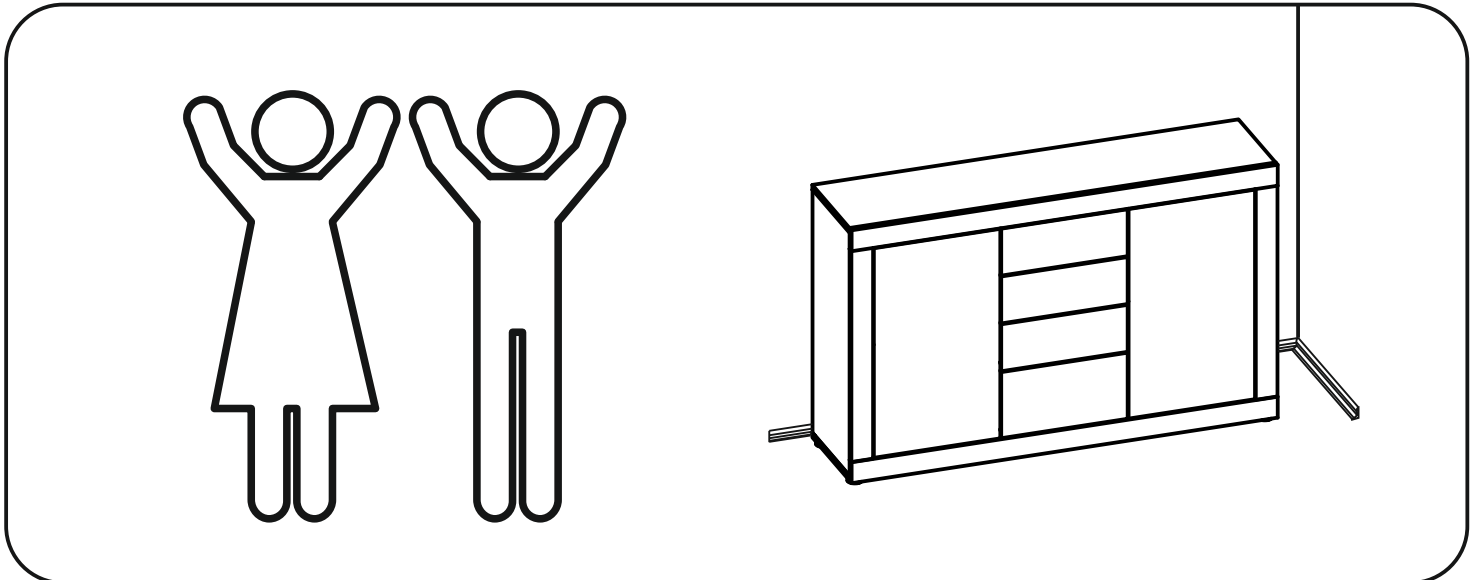
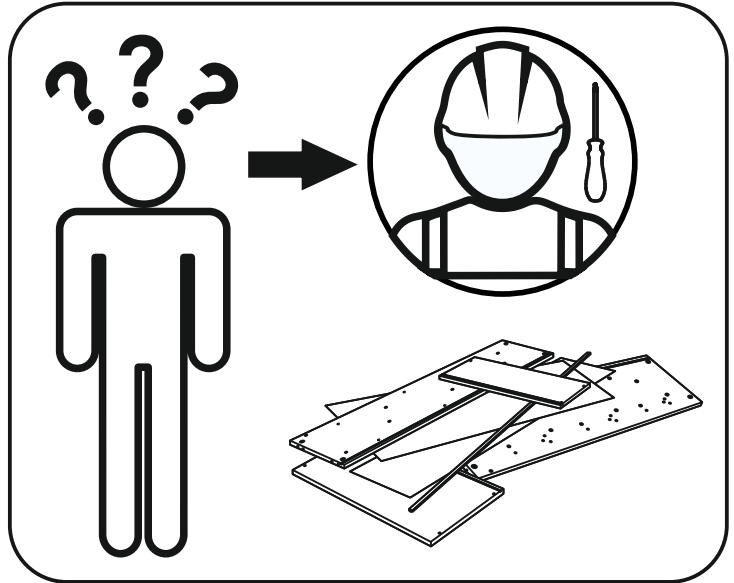
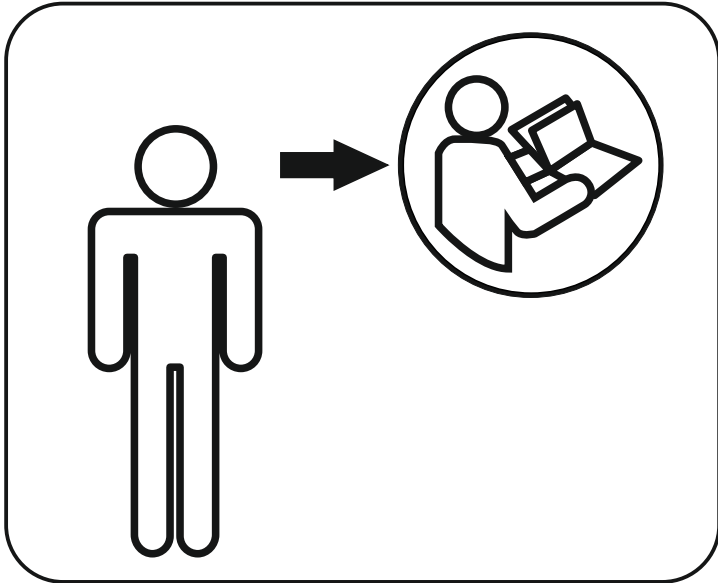
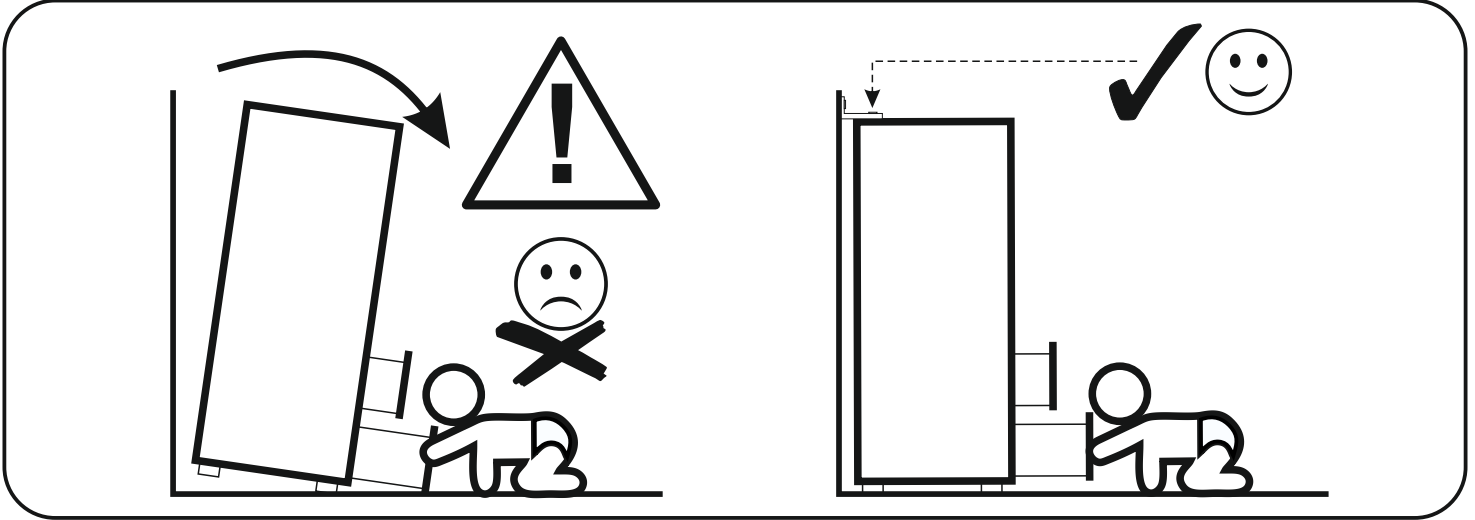
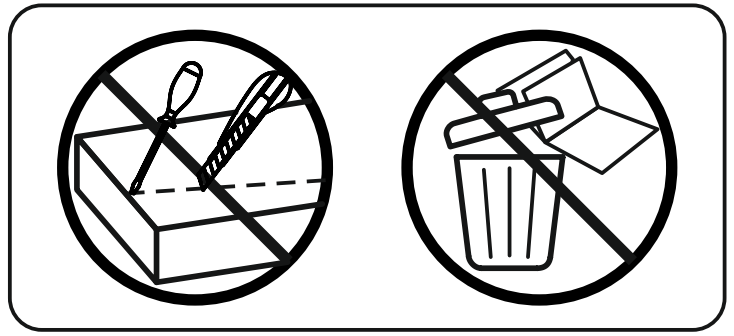
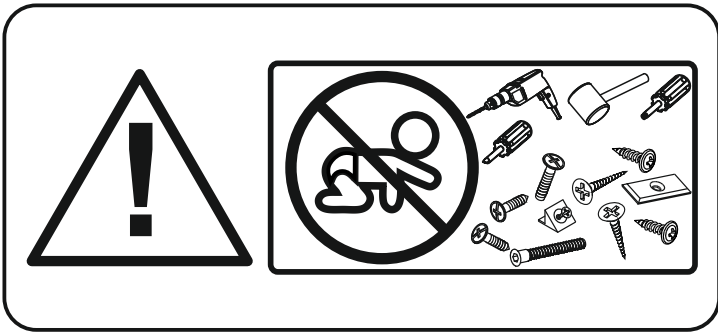





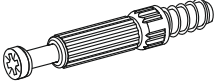
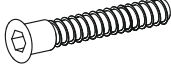

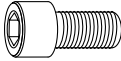
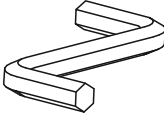
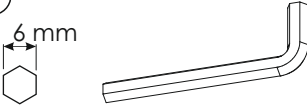
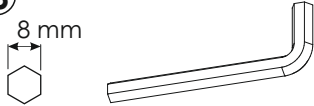
## OPTION



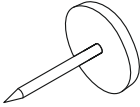

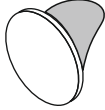
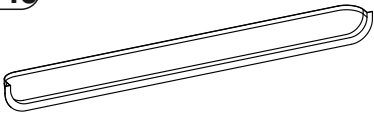
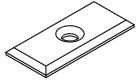
# FANZ03

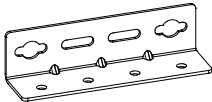
<b>A1</b> 8 x 35 mm x22 	<b>A6</b> 8 x 24 mm x12 	<b>E1</b> 15 x 12 mm x8 
<b>F1</b> 6 x 34 mm x8 	<b>G2</b> 7 x 60 mm x12 	<b>I0</b> 3 x 13 mm x10 
<b>I9</b> 4 x 20 mm x32 	<b>K50</b> 8 x 25 mm x6 	<b>M</b> x1 
<b>M7</b> 6 mm x1 	<b>M8</b> 8 mm x1 	<b>N1</b> 3 x 16 mm x65 
<b>N17</b> 4 x 45 mm x24 	<b>O2A</b> ø20 x12 	<b>O2</b> x23 
<b>P16</b> x28 ø14 	<b>P17</b> x6 ø20 	<b>P40</b> x2 
<b>R1</b> x13 	<b>S10</b> x6 	<b>S18</b> x6 
<b>W14</b> x4 		

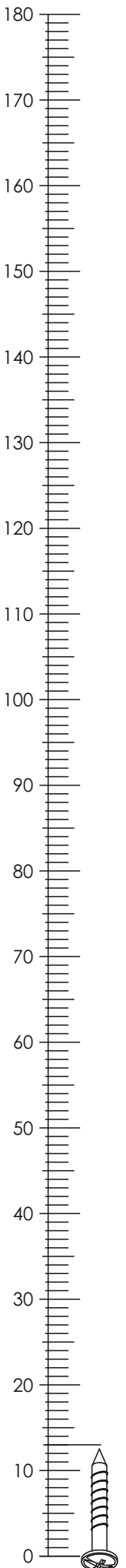

# FANZ03

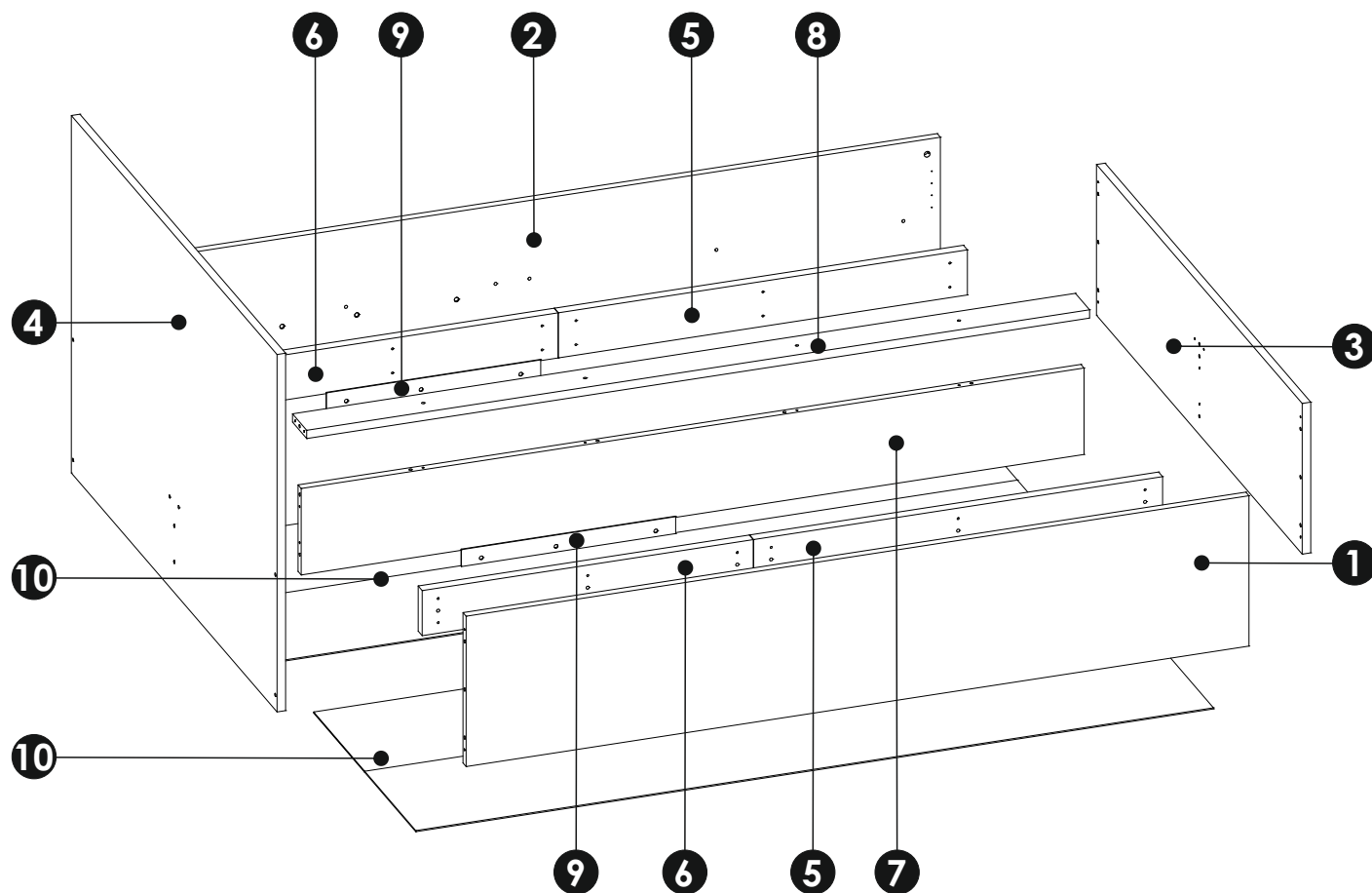
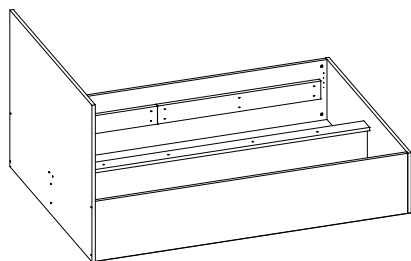

<b>1</b>	2010	400	22	x1	2/3	<b>6</b>	850	120	28	x2	1/3
<b>2</b>	2010	400	22	x1	2/3	<b>7</b>	2010	230	22	x1	1/3
<b>3</b>	1451	401	22	x1	3/3	<b>8</b>	2010	100	22	x1	1/3
<b>4</b>	1451	951	22	x1	3/3	<b>9</b>	550	45	3	x2	1/3
<b>5</b>	1050	120	28	x2	1/3	<b>10</b>	2048	720	3	x2	1/3



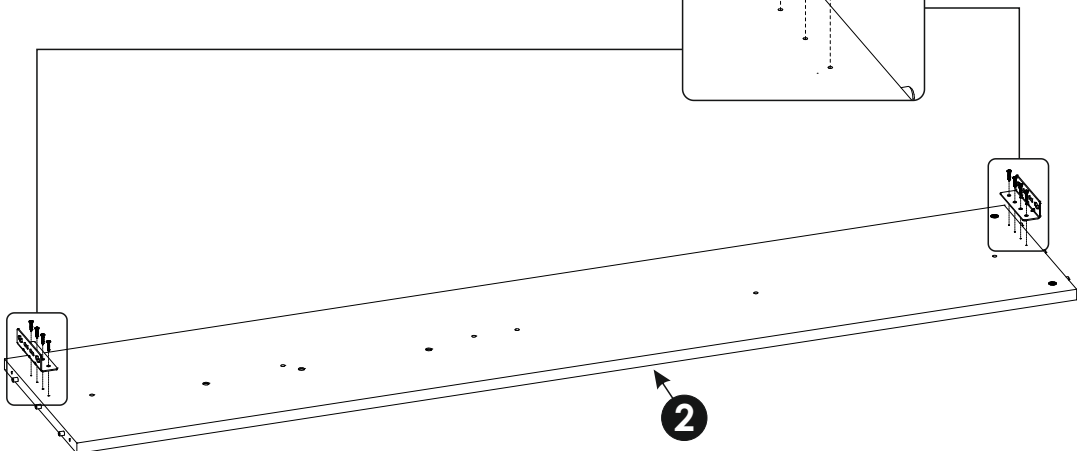
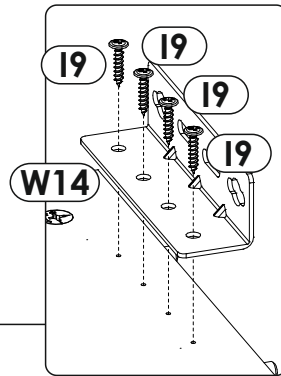
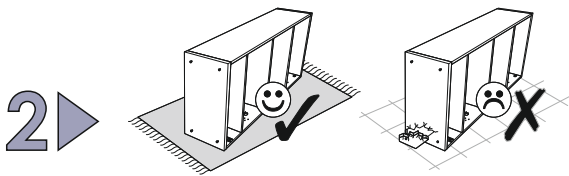
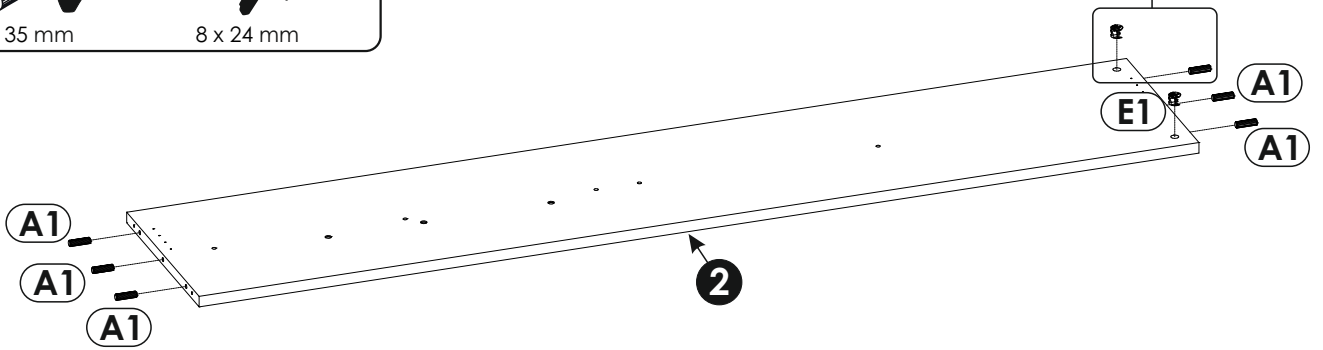
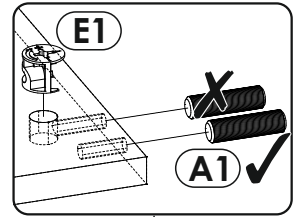
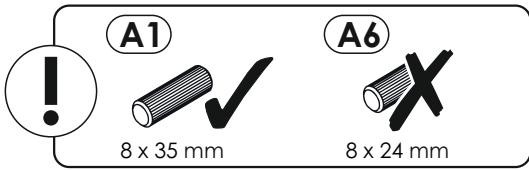
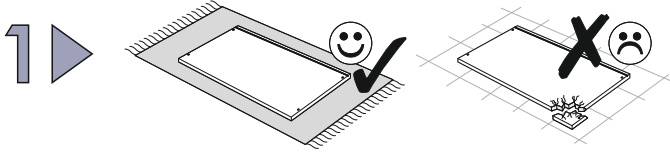
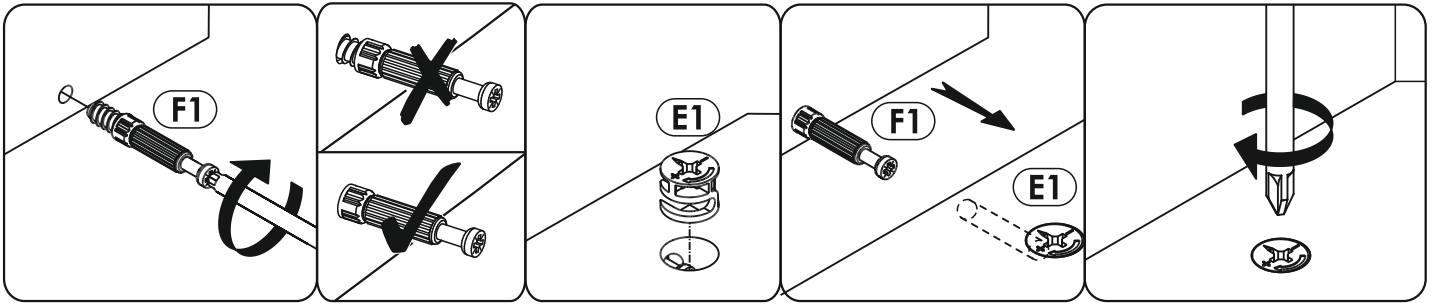

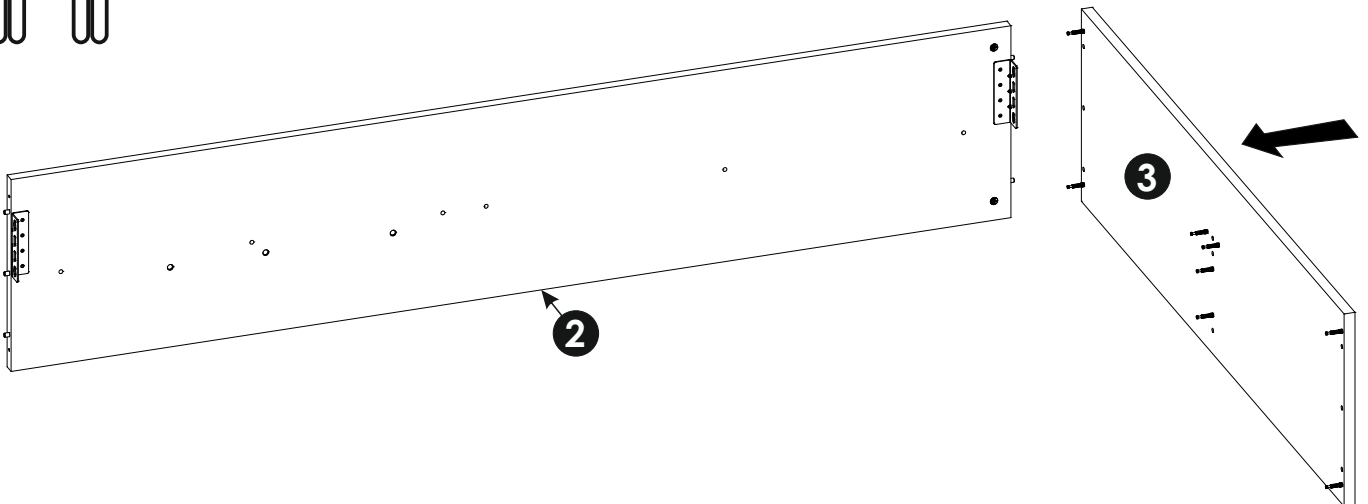
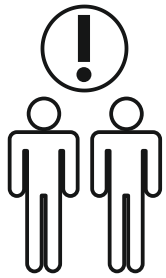
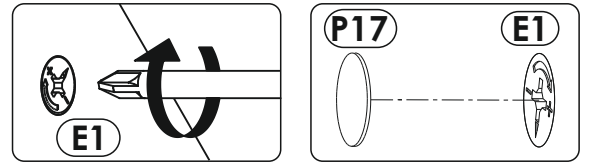
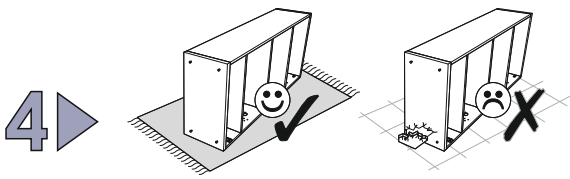
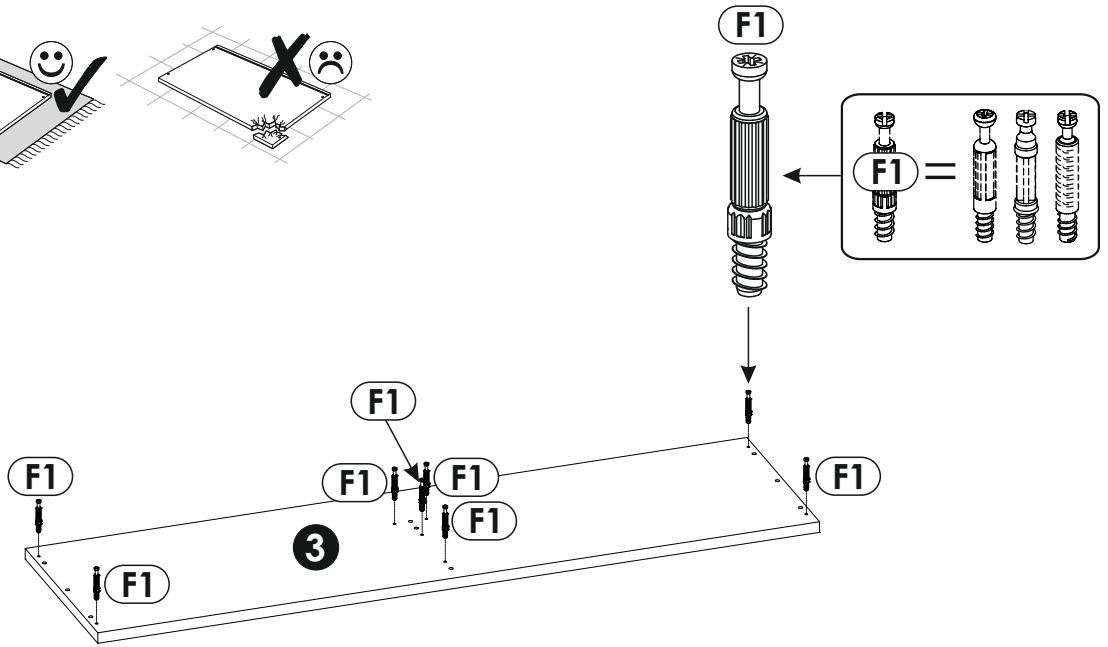
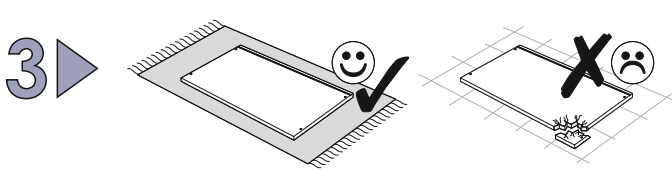

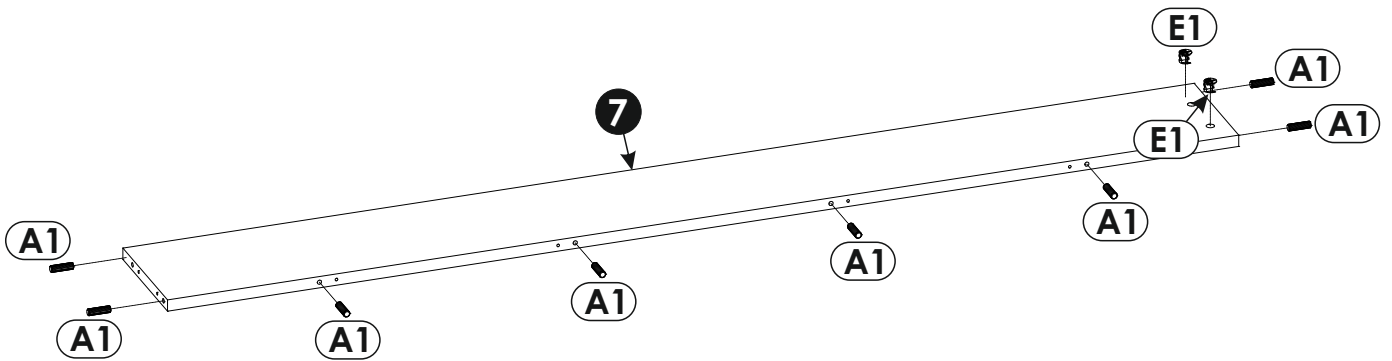
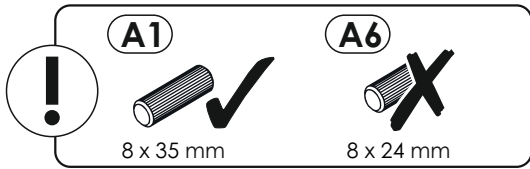
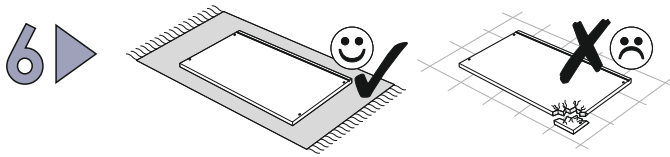
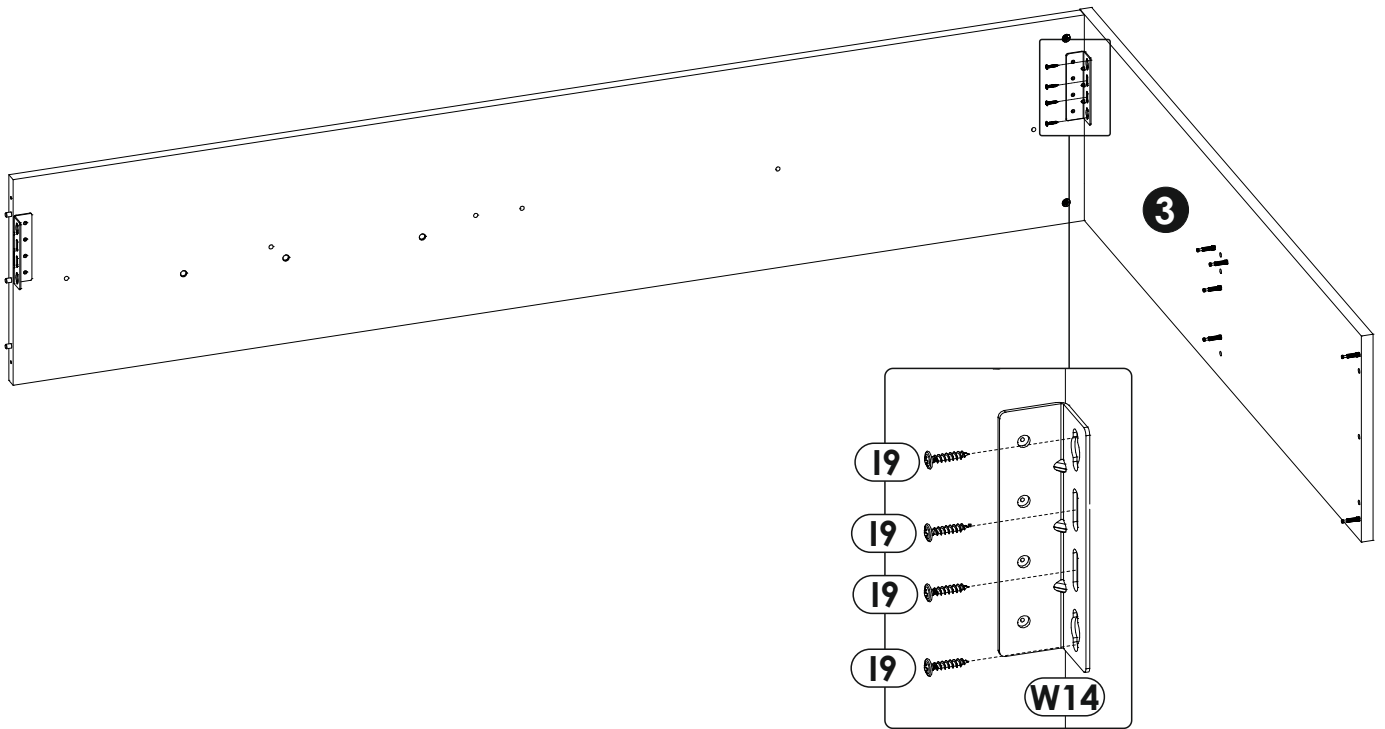
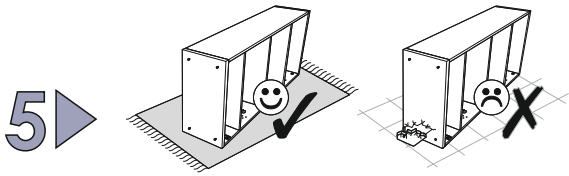

7 ▶

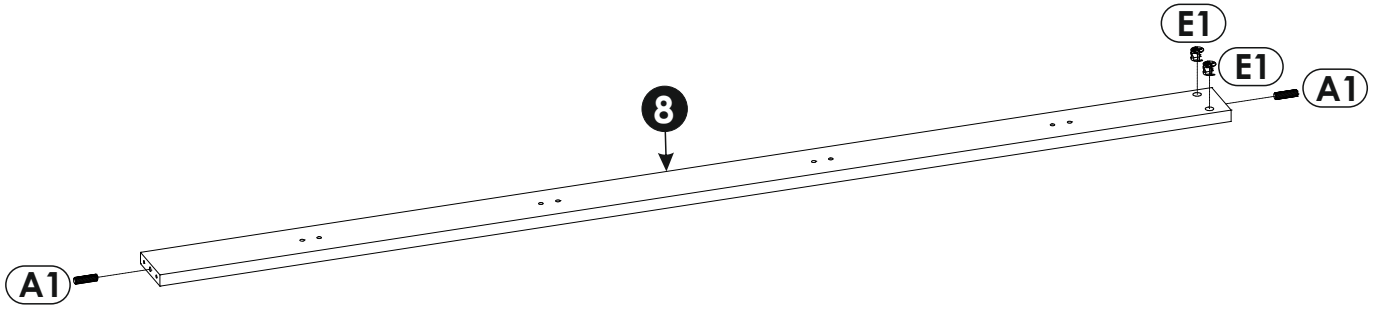
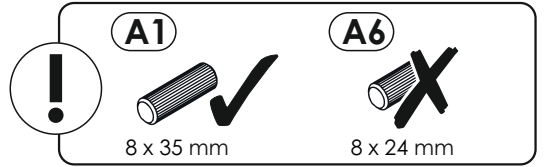
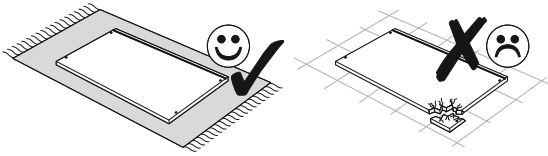

8 ▶

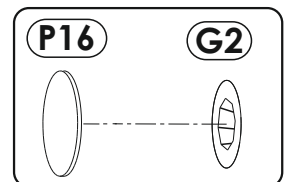
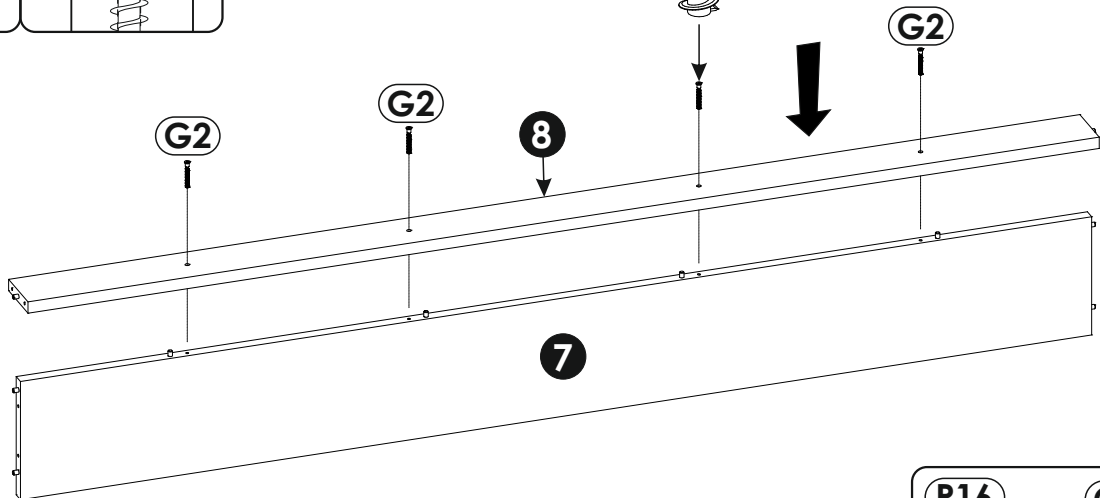
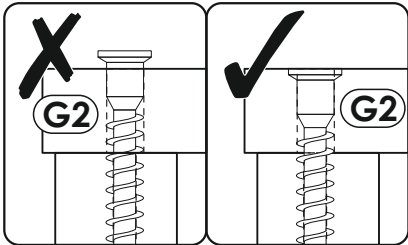
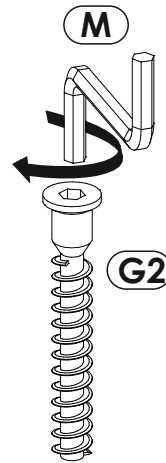
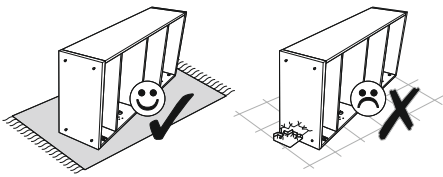

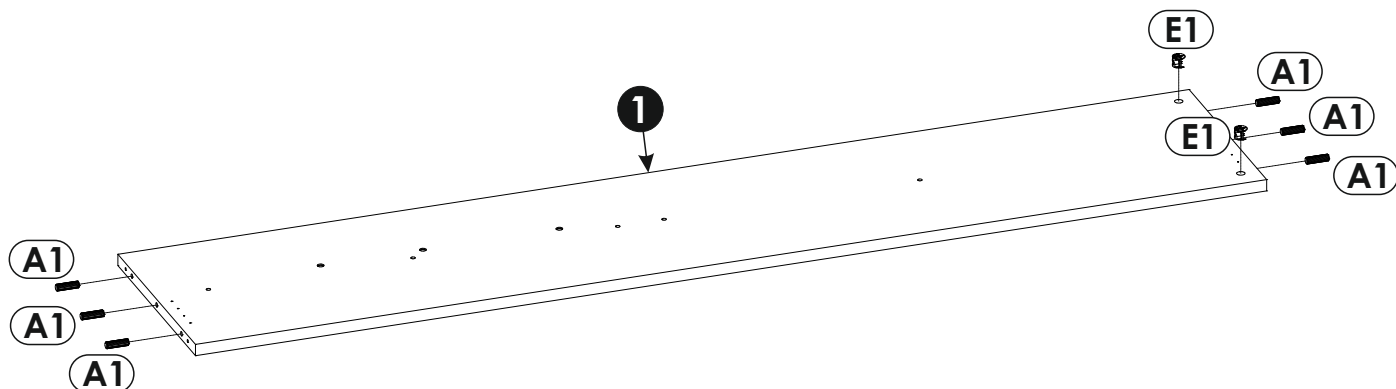
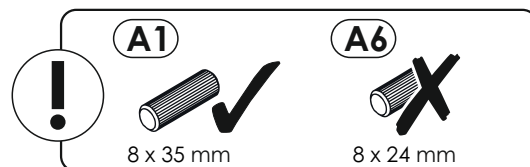
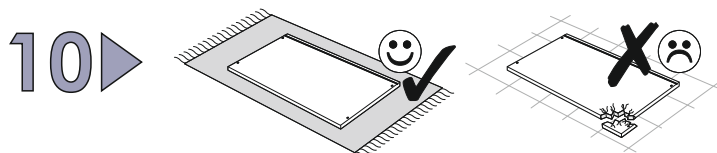
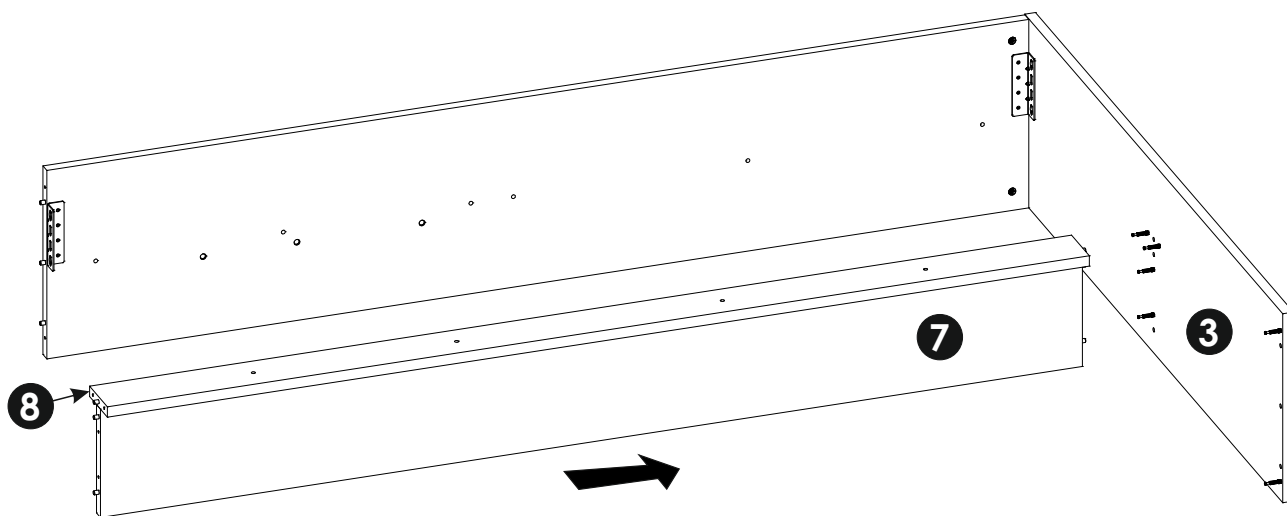
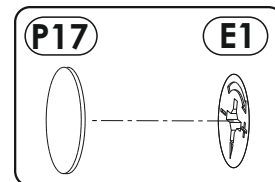
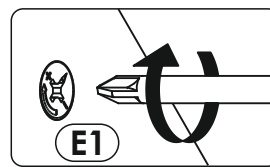
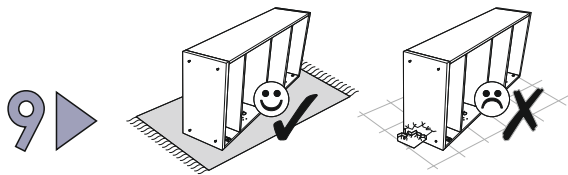

11 ▶

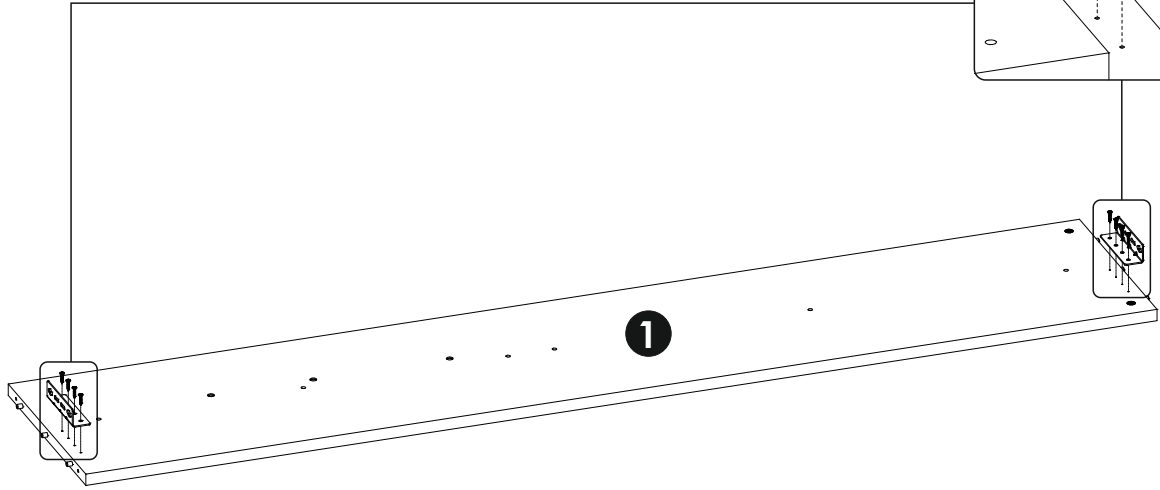
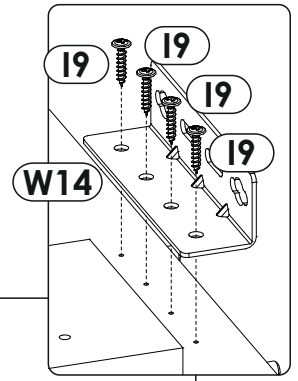
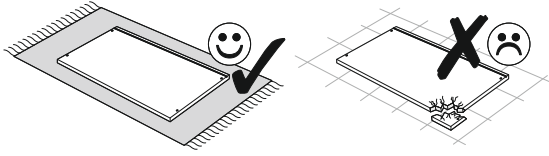

12 ▶

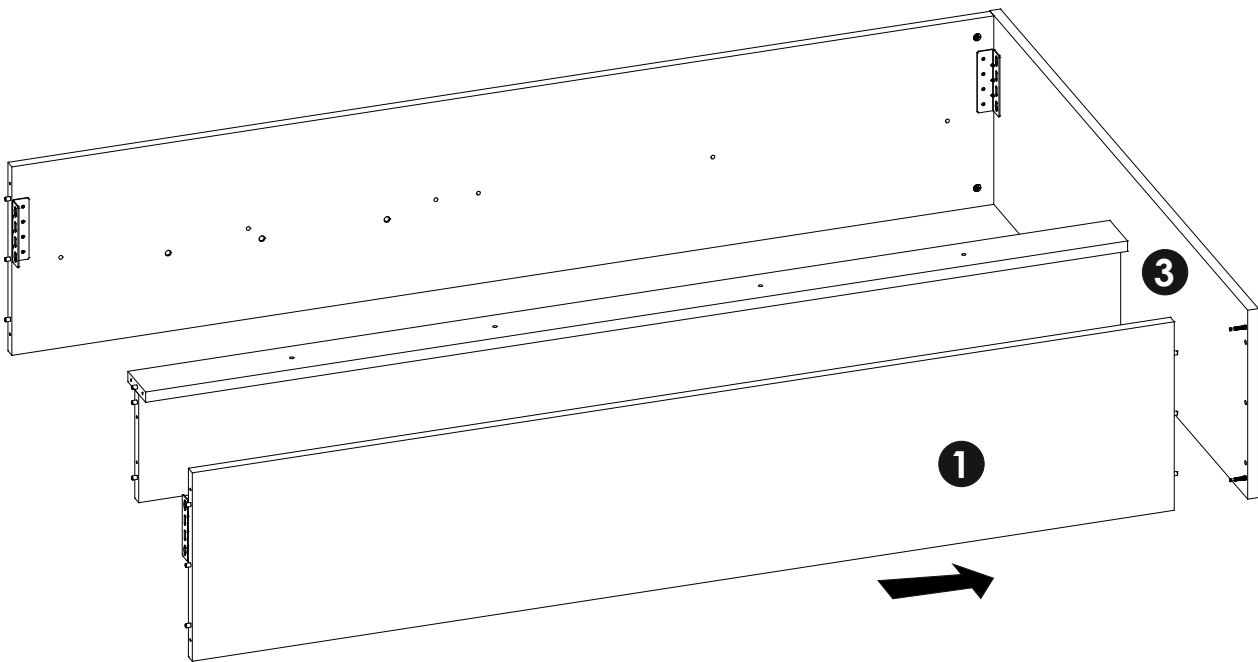
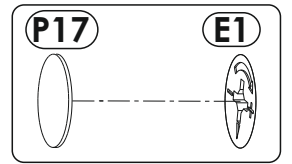
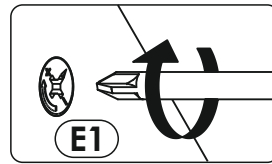
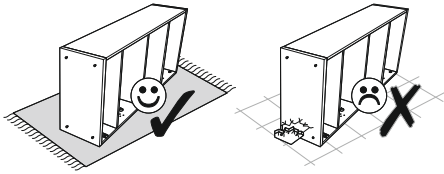

13 ▶

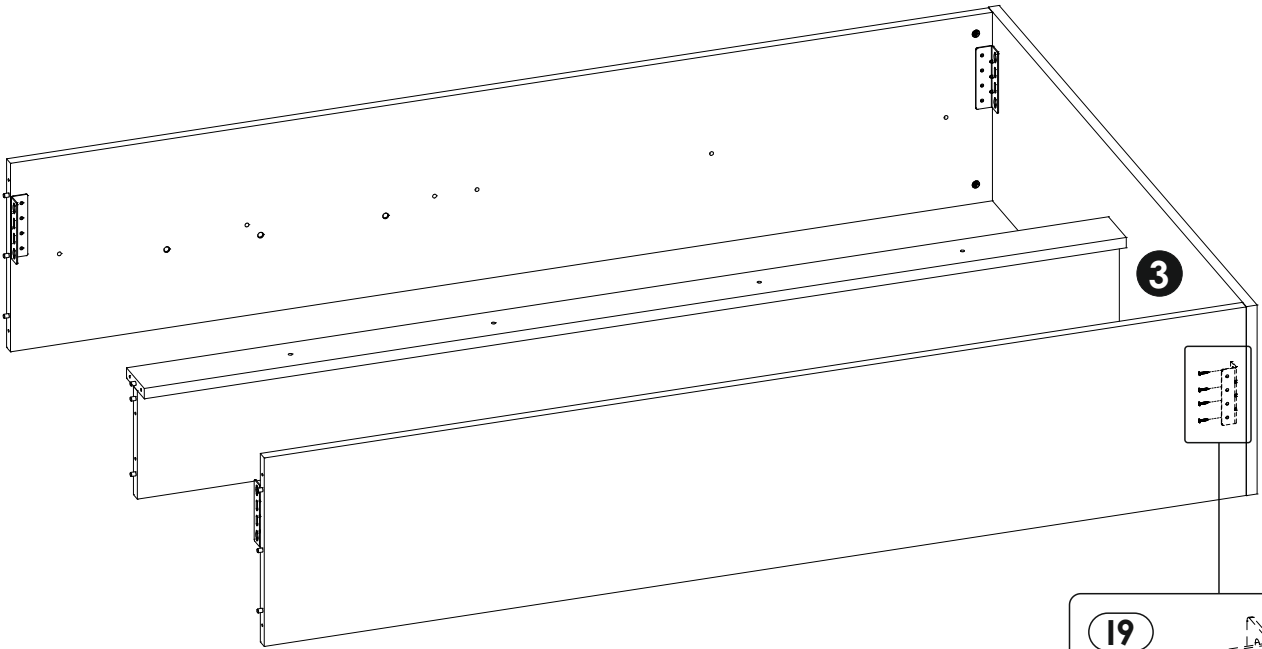
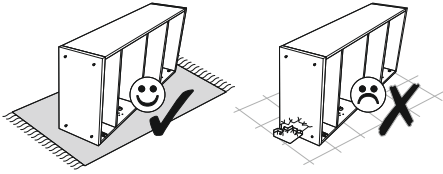

14 ▶

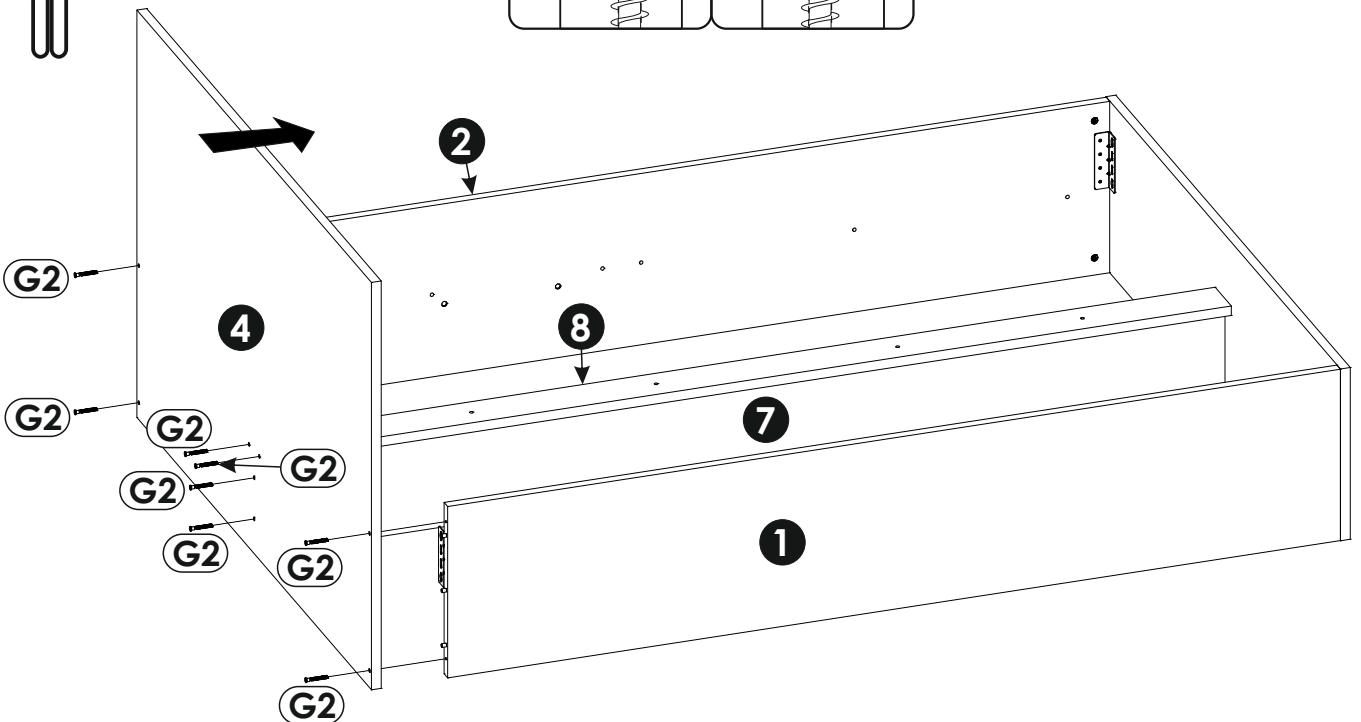
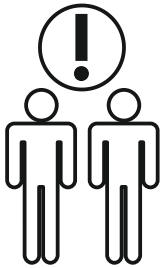
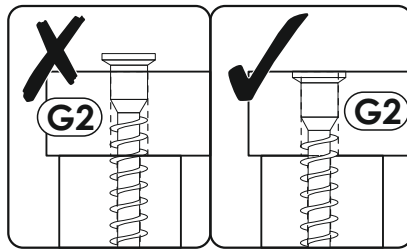
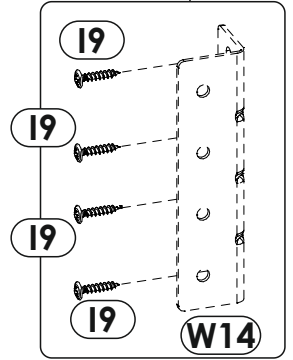
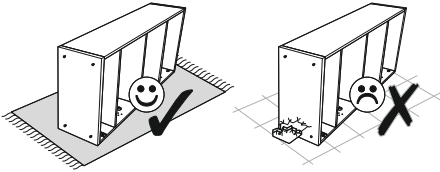

15 ▶

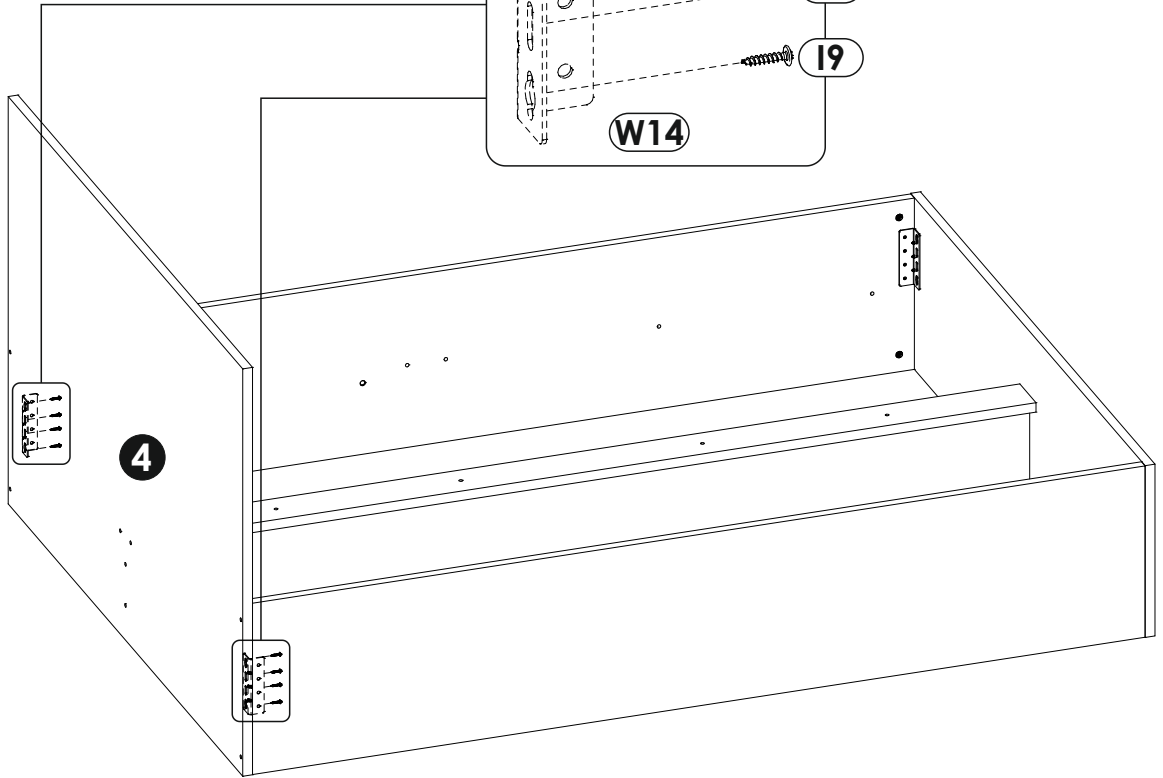
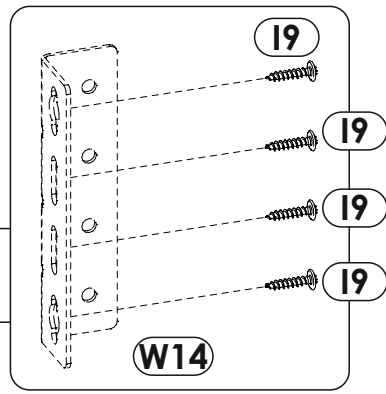
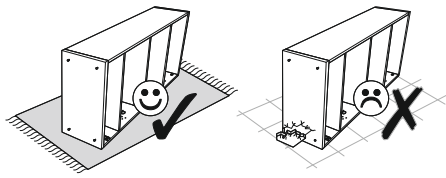

16 ▶

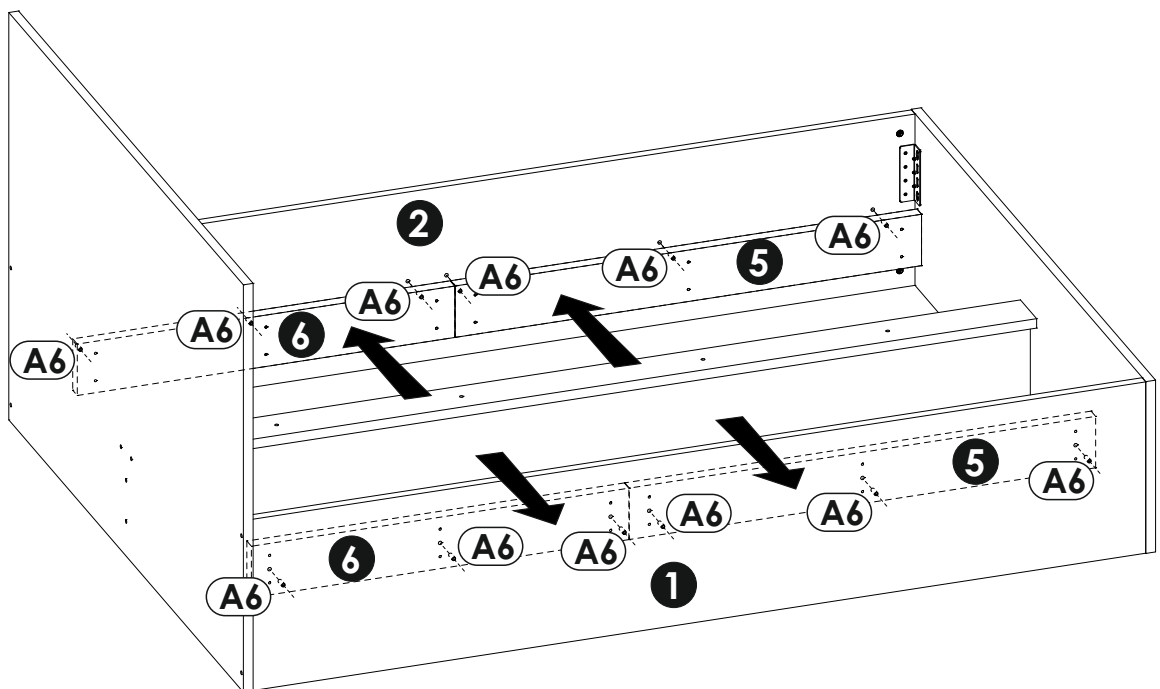
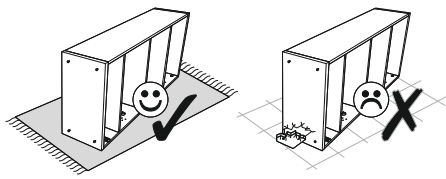



17 ▶

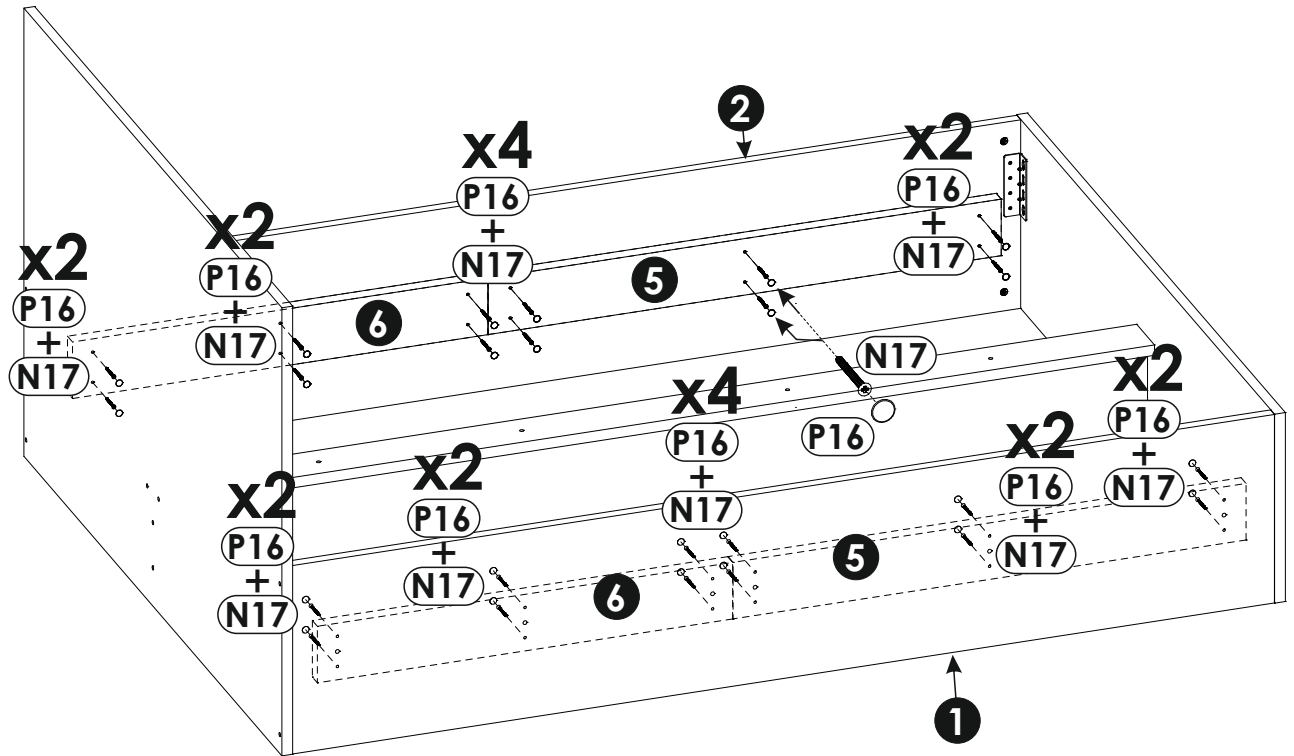
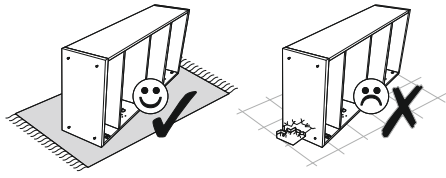

18 ▶

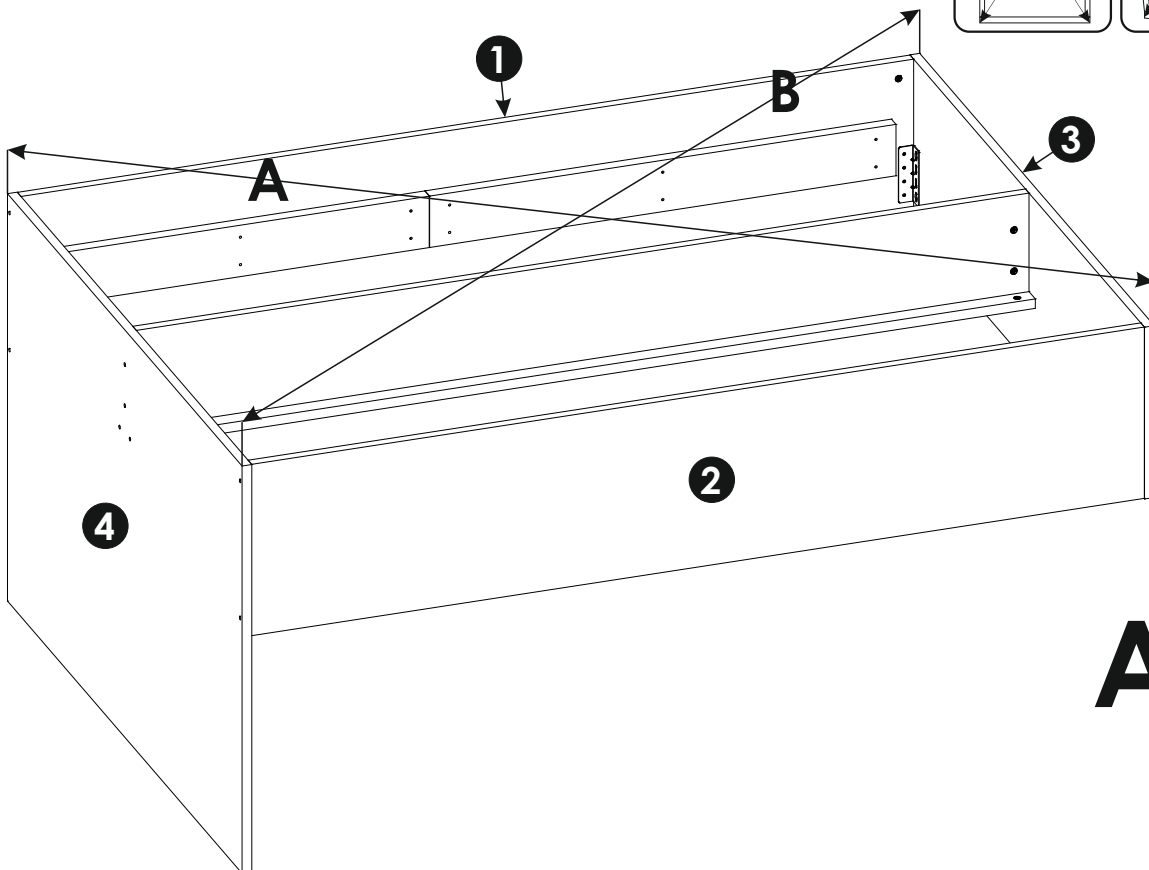
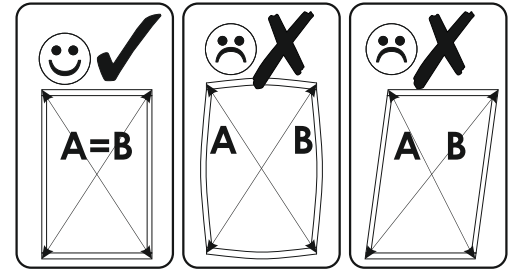
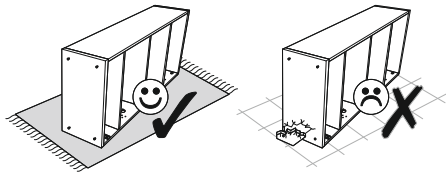

**A=B**

19 ▶

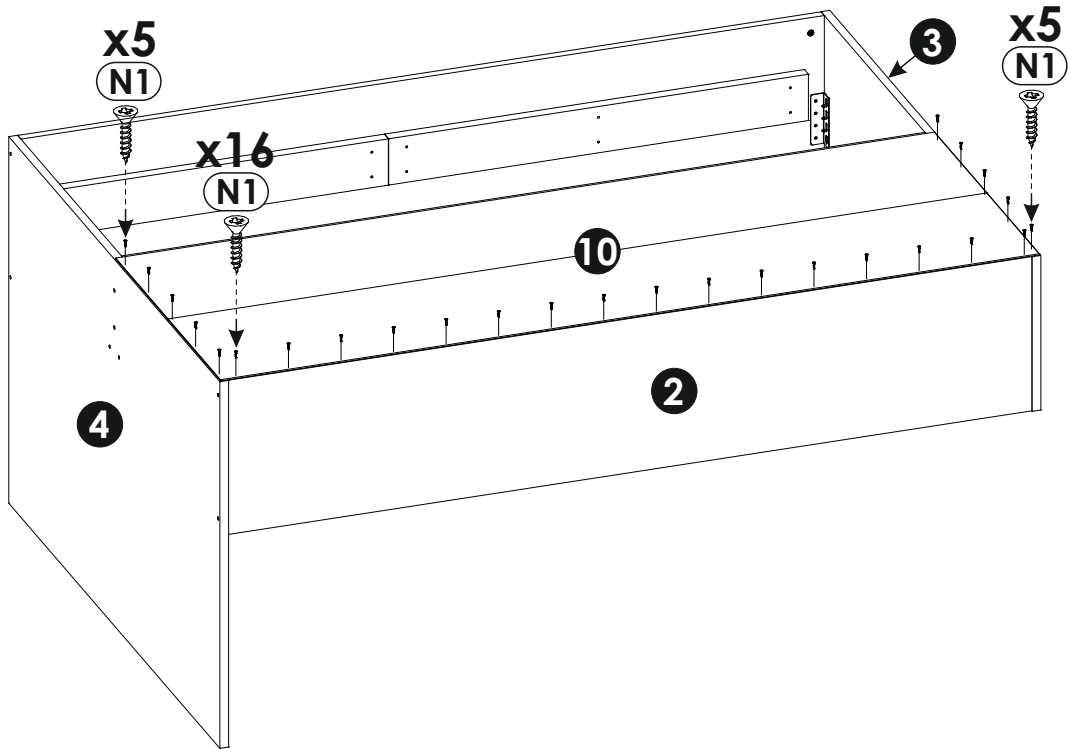
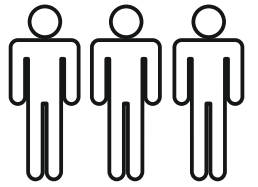
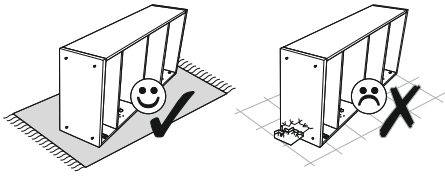

20 ▶

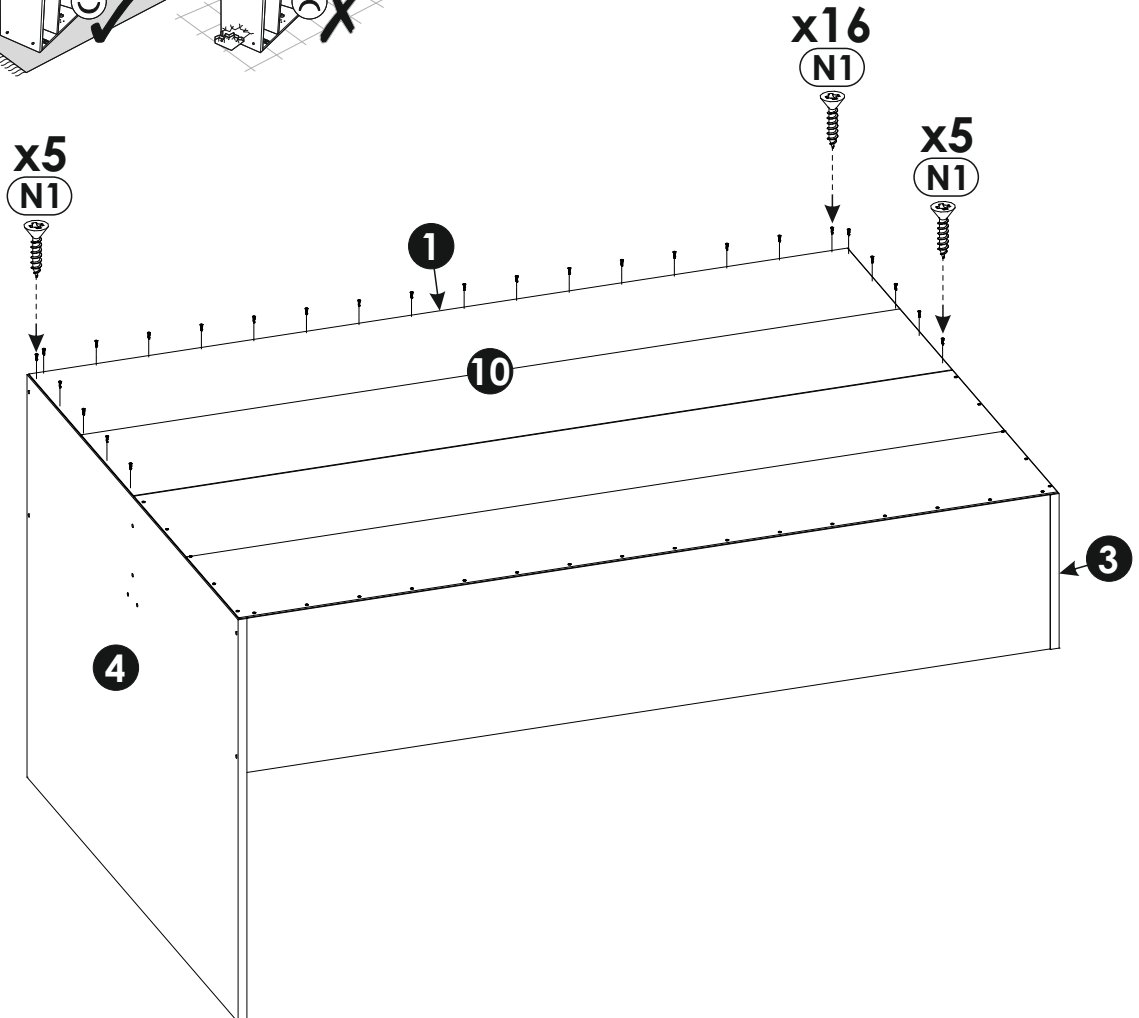
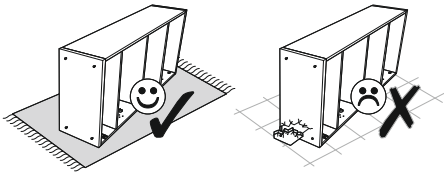

21 ▶

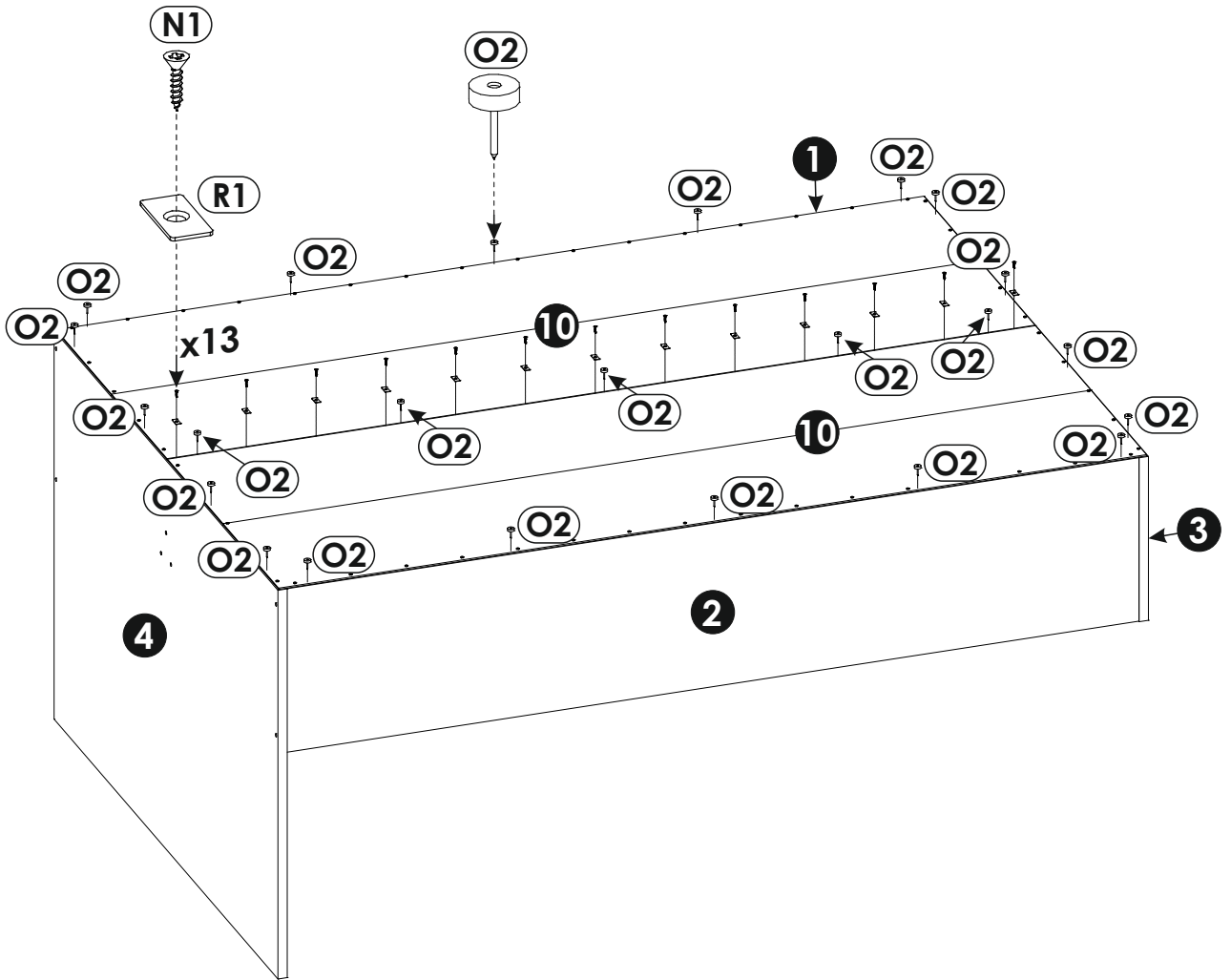
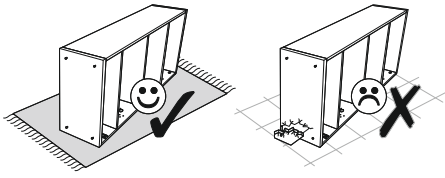

# OPTION

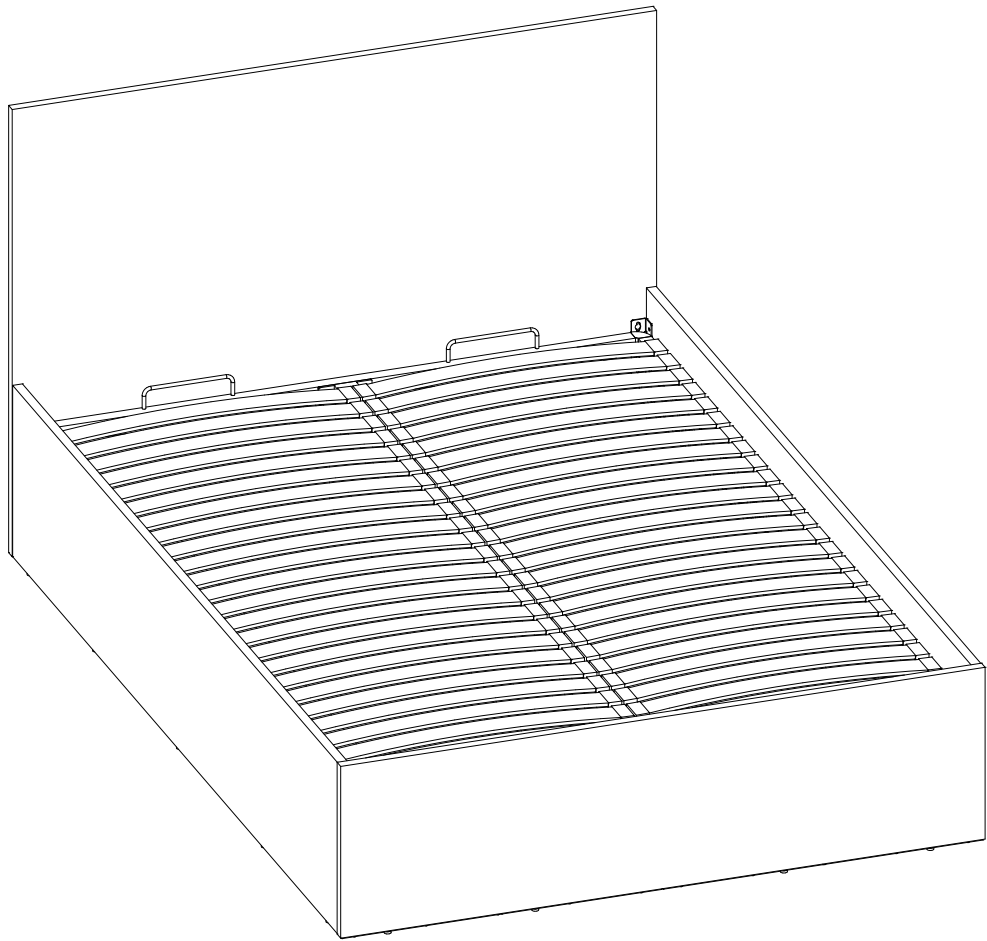

22▶

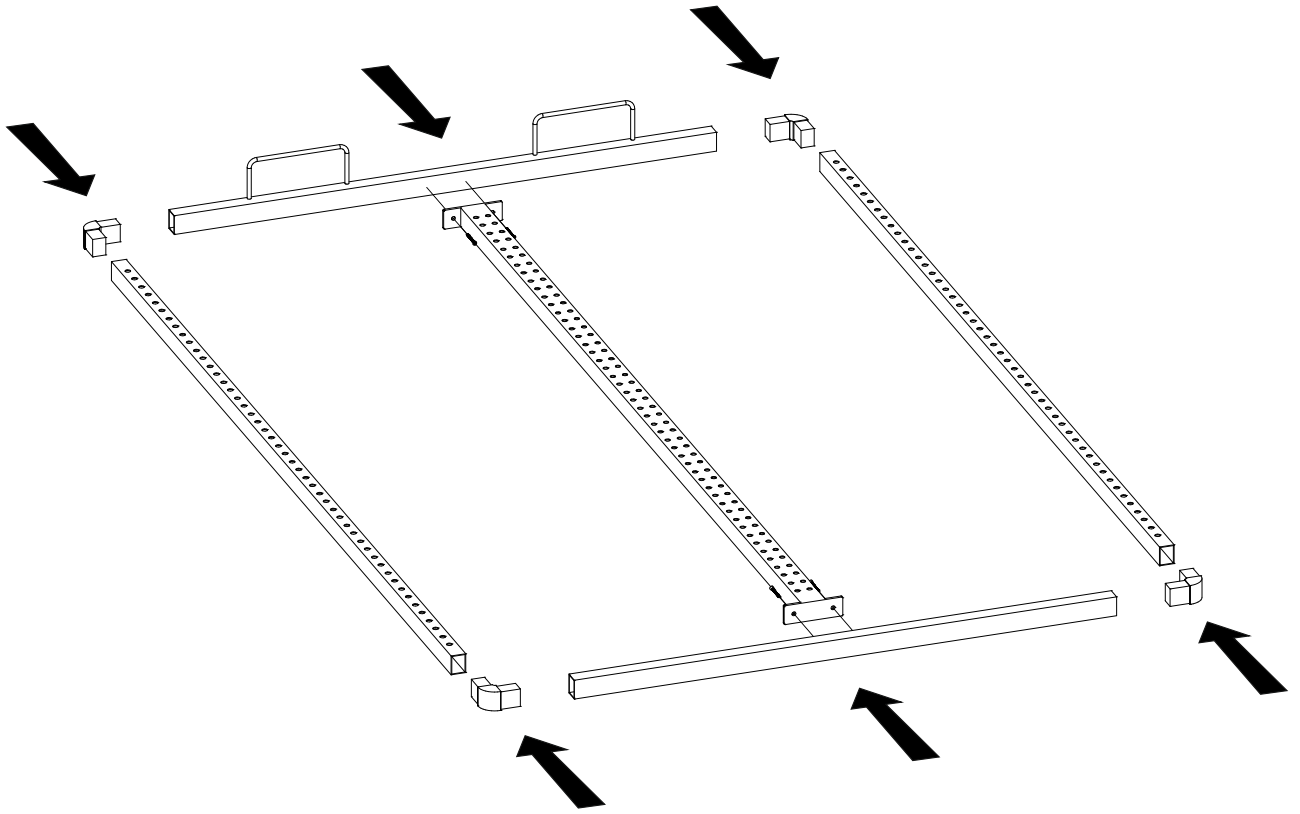

23▶

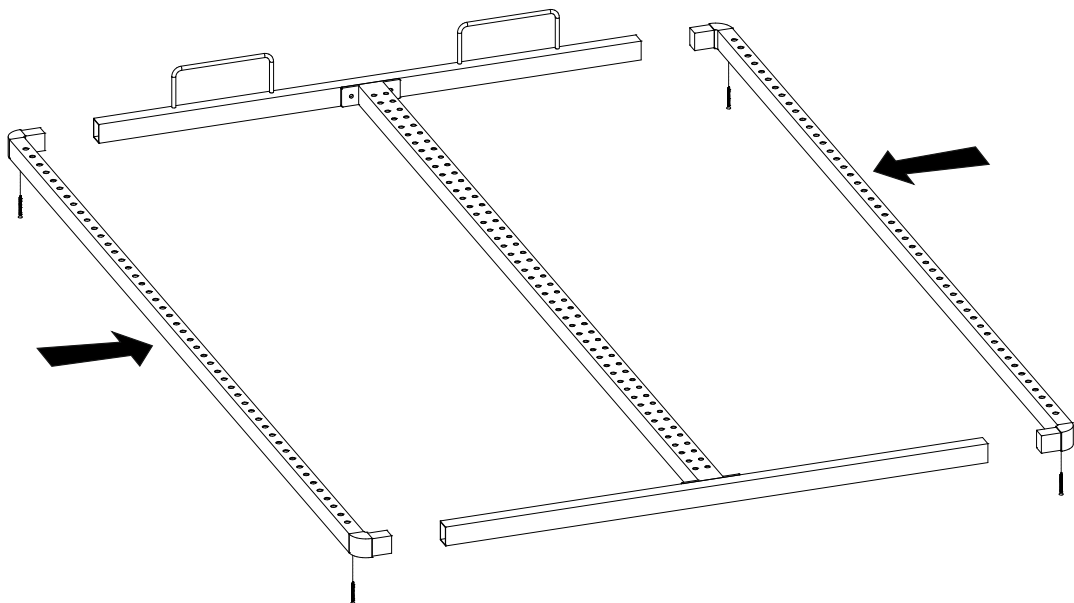

24▶

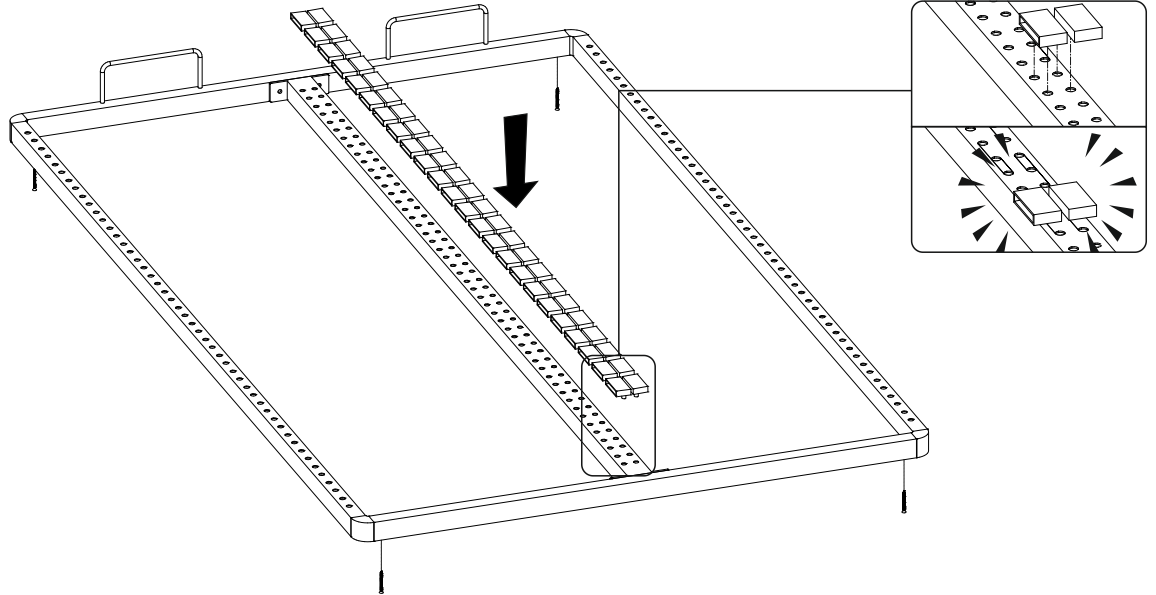

25▶

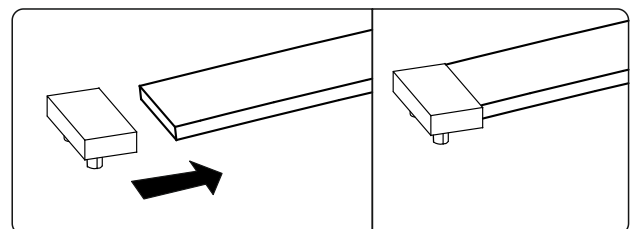
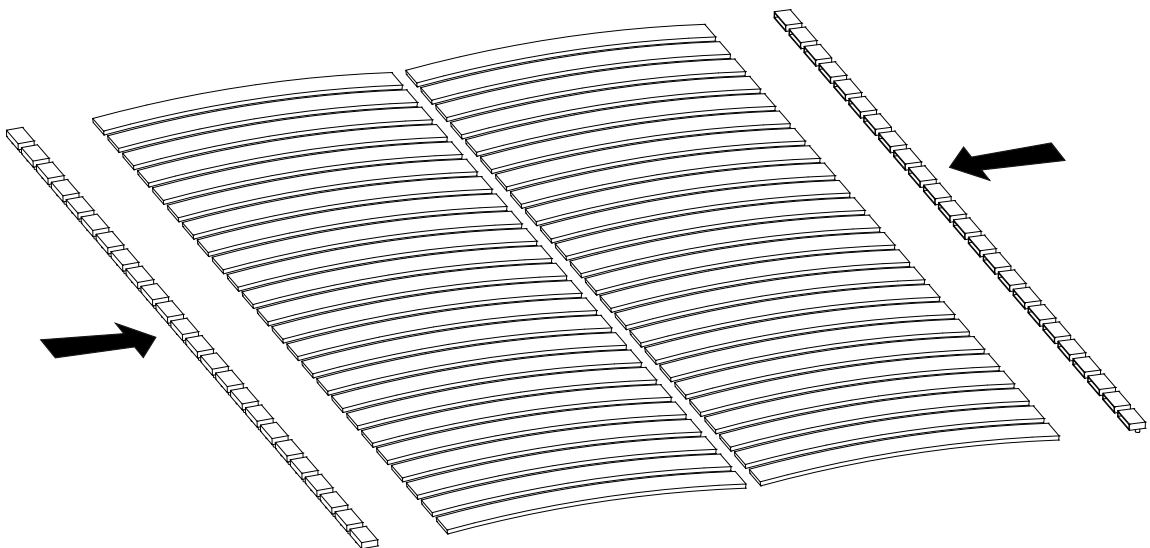

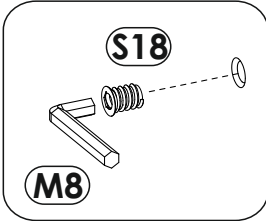
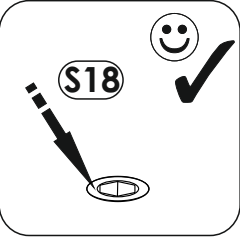
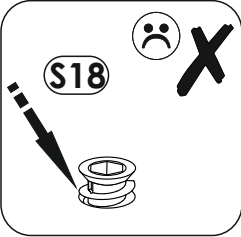
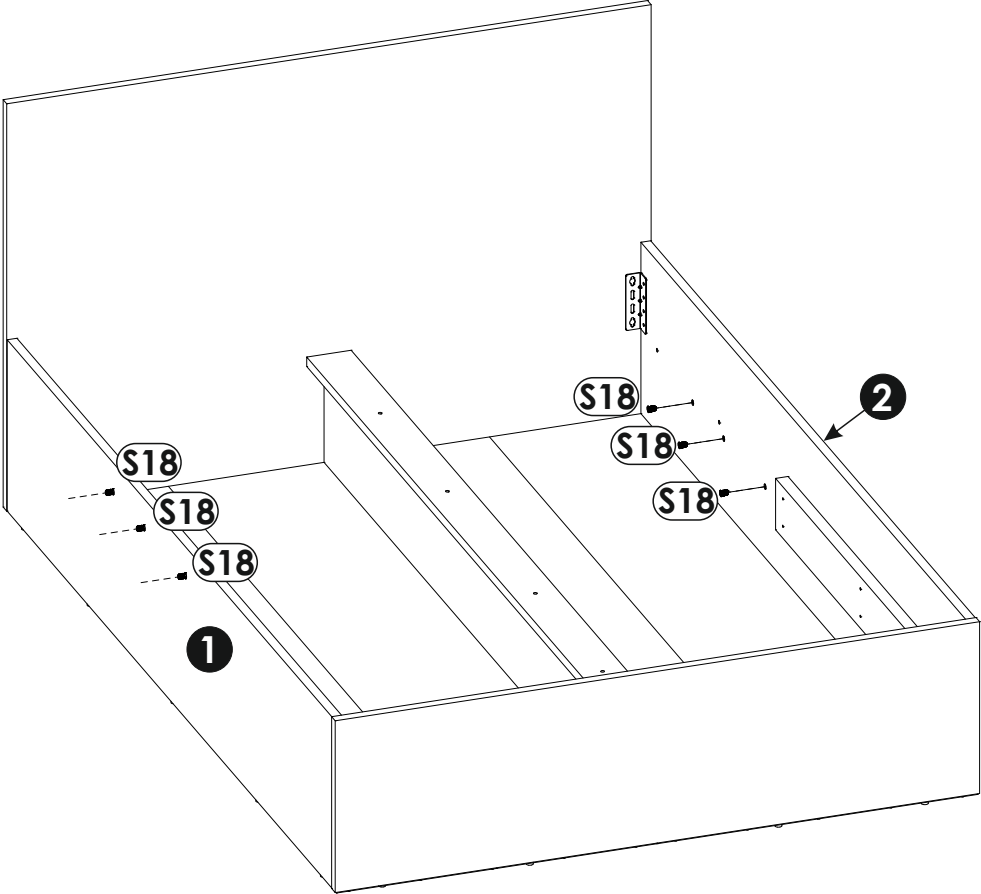

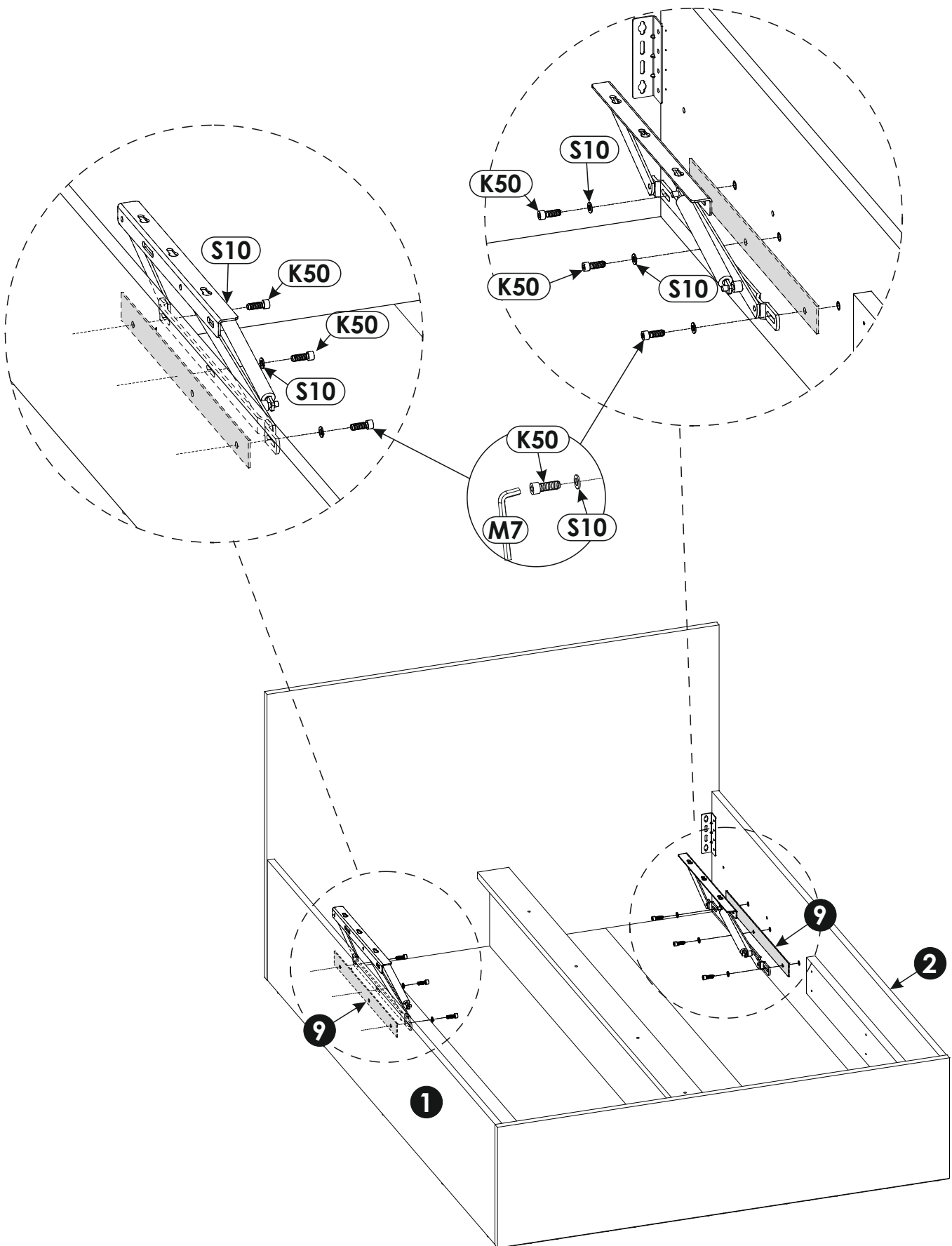



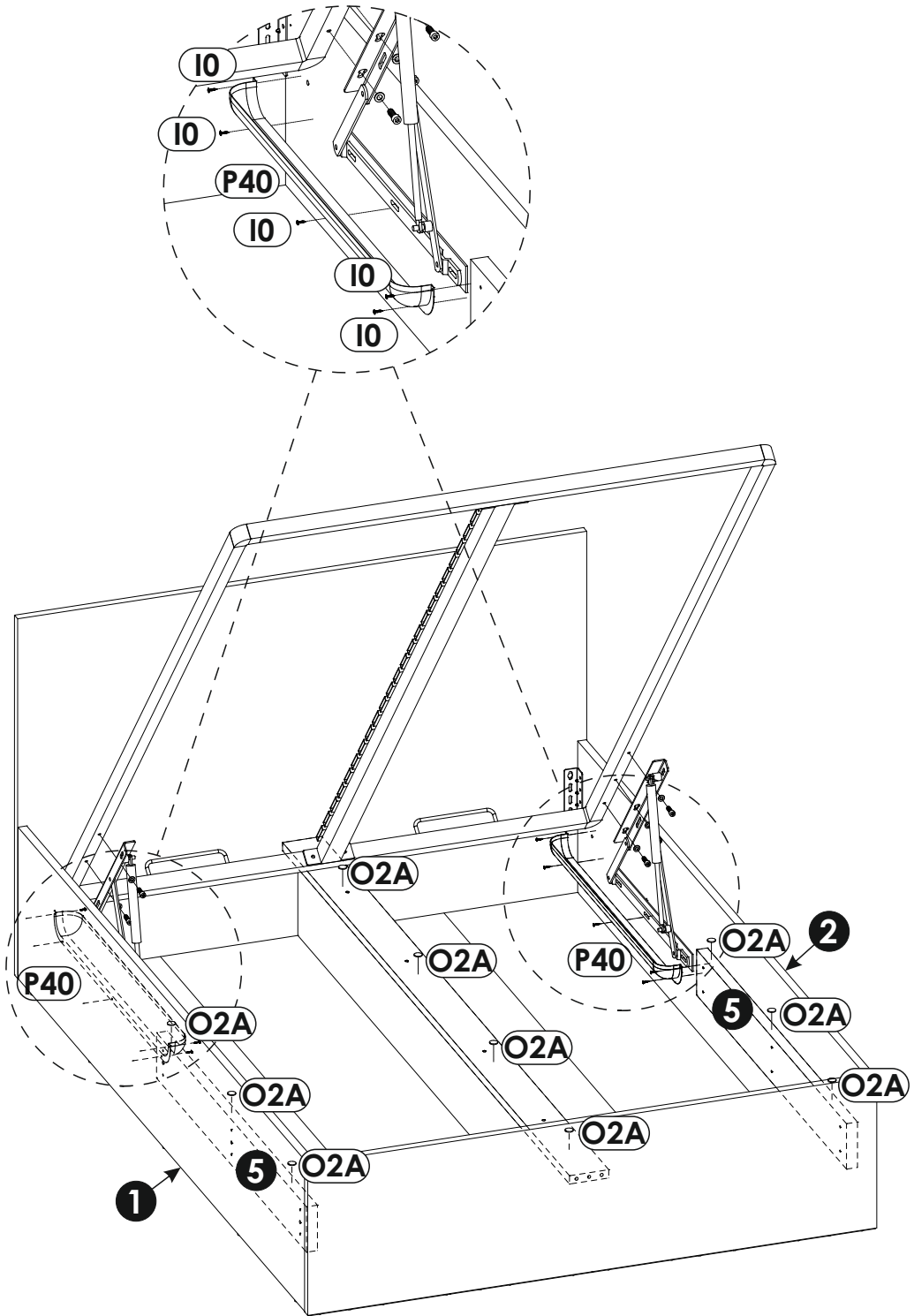

29 ▶

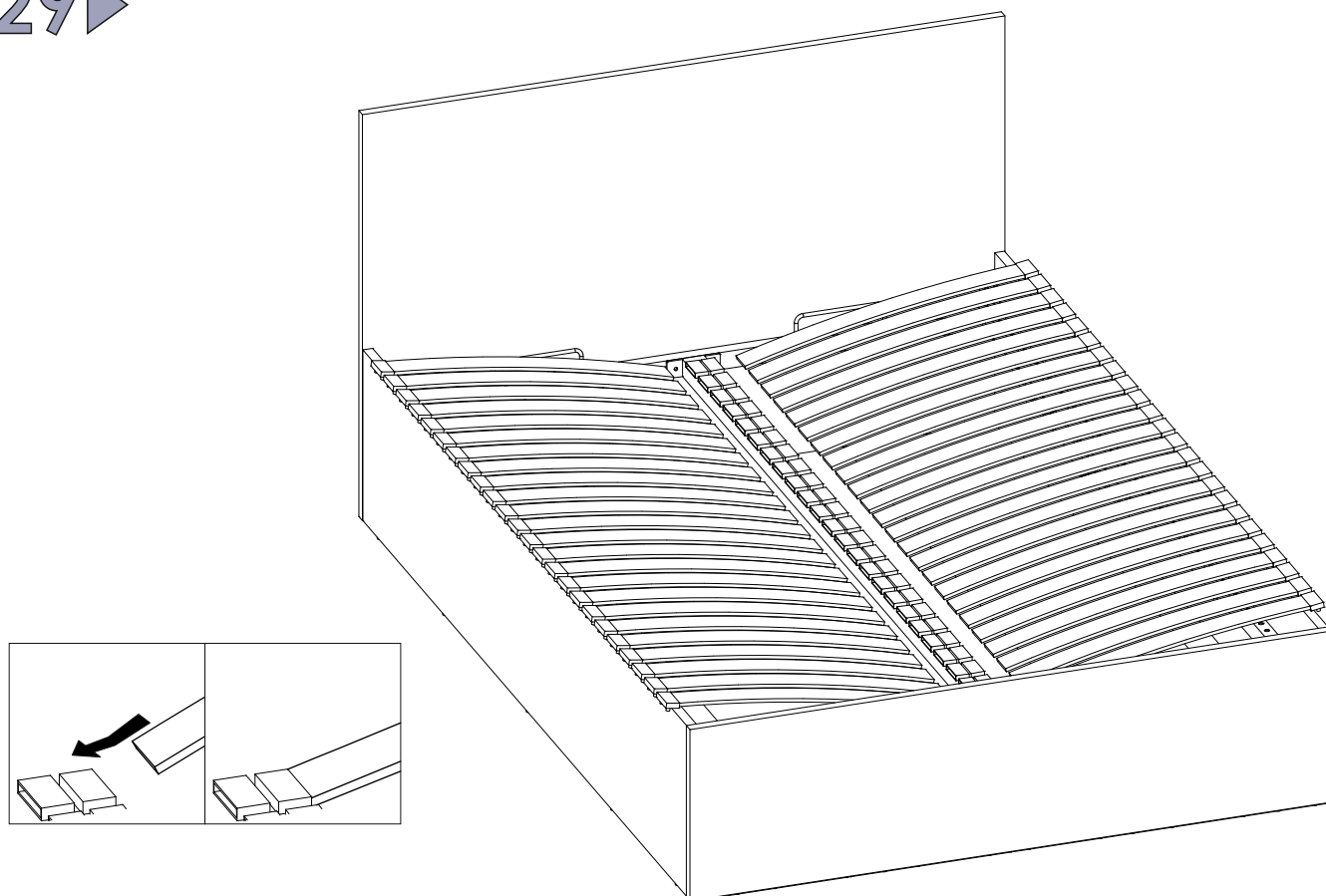

30 ▶

